

GET OUTSIDE THE EVERYDAY



Sustainability Matters

MoistureShield is committed to working towards a cleaner, waste-free world.

That's why we build our decking boards* with **95% recycled content**, much of it material that we help divert from landfills. 100% of the wood we use is recycled, so no trees are cut down to make our product. That's more than 65 million pounds of wood fiber we recycle every year, or the equivalent of more than 15,000 trees. 25% of the plastic we use comes from post-consumer waste — like plastic bags and bottles — so they become part of beautiful decks rather than landfills or pollution.

Because we believe in being part of the sustainability solution, we choose to reuse materials to make new, better things.

**Does not include Stratos Composite Enhanced PVC Decking.*



Build Green with MoistureShield

Our decking contributes to LEED green building certifications with over 95% recycled material.



● Pre-consumer recycled content

● Post-consumer recycled content



The average American uses **110 pounds** of single-use plastic every year.



We take the waste of about **250,000 Americans** and use it to create our high-performance decking.

THAT'S 125 MILLION POUNDS of wood fiber, plastic regrind, rigid plastics and film plastics we divert from landfills every year.
(More than two Statues of Liberty!)

Excel Every Day. Product innovations that improve your everyday life, offering enduring beauty that reduces the need for routine maintenance.

Defy Ordinary. Built to outlast the elements, our wood composite deck boards can be installed on the ground, in the ground or underwater.

Inspire Life. Create inspired outdoor living spaces, from the social spot to the play area, with gorgeous finishes and unmatched performance.

zerO Failures



We're the only decking product with zero structural field failures for more than 30 years. Visit our website to learn more about why that matters and how we stack up against the competition. [MoistureShield.com/Why-MoistureShield](https://www.moistureshield.com/Why-MoistureShield)



Excel Every Day



Decking

Our offering provides beautiful options for every project. Create bold and inspired outdoor living spaces that stand up to the effects of weather and wear.

Stratos™ _____ | *pg. 8*

Vision® _____ | *pg. 16*

Meridian™ _____ | *pg. 18*

Elevate™ _____ | *pg. 20*

Vantage™ _____ | *pg. 22*

Marine Grade 2x _____ | *pg. 24*

Cladding _____ | *pg. 32*

InstaDeck® _____ | *pg. 34*

Joist Tape _____ | *pg. 35*

Hidden Fasteners _____ | *pg. 36*

Railing

Complete your dream deck with a picture-perfect railing. Choose from aluminum, steel or composite deck railing systems.

Compass™ Aluminum Railing _____ | *pg. 42*

Fathom™ Steel Railing _____ | *pg. 44*

Navigator™ Composite Railing _____ | *pg. 46*

Discovery™ Composite Railing _____ | *pg. 48*

Traverse™ Composite Railing _____ | *pg. 50*

Lighting _____ | *pg. 52*

Posts & Accessories _____ | *pg. 53*

Deck Style Meets Lifestyle

This product overview guide is designed as a quick reference to help you understand which of our products may best meet your needs. For example, families in hot climates and with young children will want to choose products with our CoolDeck Technology. If you have a rustic, wood-heavy interior design or you live in a forested environment, our Meridian decking will pair beautifully. Heavily-trafficked decks should be made with our Vision or Stratos decking.

Consider the following questions before choosing the right decking:

- Do you have young children or pets?
Choose Stratos, Vision or Vantage for high slip resistance.
- Does your region experience many hot summer days?
Choose Stratos, Vision or Meridian with CoolDeck.
- What kind of style do you have in your home?
For a rustic look and feel, choose Vision or Vantage.
For modern, refined colors, choose Elevate, Meridian or Stratos.
- How often do you entertain large groups?
For heavy foot traffic, choose Vision or Stratos.
- Are you designing a home dock or pier?
For highest durability, choose Vision Marine Grade 2x or Stratos. For an authentic wood look, choose Vantage Marine Grade 2x.
- Are you interested in decking that will last for many years and is low maintenance, but are also concerned about staying within your budget?
Choose Elevate. Its scalloped bottom reduces cost while still offering our Solid Core protection giving it the same 50-Year Structural warranty that is available on all MoistureShield's decking lines.



Stratos with CoolDeck Technology

Meticulously designed to be stronger and longer-spanning than any PVC decking on the market



Vision with CoolDeck Technology

Extremely durable decking built for bare feet, pet claws, summer heat and sports cleats



Elevate

Affordable and high-performing composite decking with a strong, protective barrier



Meridian with CoolDeck Technology

Authentic premium wood look with colors built to keep even the hottest weather at bay



Vantage

Specialty decking that imitates real wood but resists damage from water and harmful elements

EXPERIENCE THE NEXT LEVEL



Introducing
StratosTM
Composite Enhanced PVC

Dive in and experience the next level in outdoor living. MoistureShield Stratos is the only deck board that fuses the impenetrable protection and beauty of PVC decking with the rigid strength of composite. It's the newest way we're pushing the limits of what's possible in outdoor living.

Get Outside the Everyday

PVC Decking Just Got Better

MoistureShield's Stratos composite enhanced PVC decking is a breakthrough innovation in outdoor flooring technology. Featuring the best of composites and PVC decking, our groundbreaking Next Core™ is meticulously designed to be stronger and longer-spanning than any PVC decking on the market. Our composite enhanced PVC has lower expansion at higher temperatures than conventional PVC decking products. That means pros can finish with tighter details across wider spans than ever and deliver decks that stay looking great for years after installation.



Comfort.



CoolDeck® Technology

Finally, composite decking that stays comfortable all season long, when every degree counts. On a hot summer day, a deck can reach temperatures of more than 160°F. That's why we designed composite enhanced PVC decking that helps reduce heat up to 35%*, staying cooler in extreme heat.

MoistureShield with
CoolDeck Technology

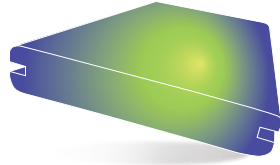

VS

Standard Capped PVC
Composite Decking

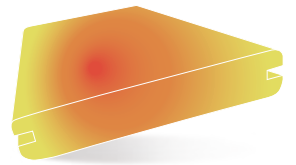

Up to
35% Less Heat

160°F+

* Reduces heat absorption by up to 35% compared to standard capped PVC composites in a similar color. CoolDeck Technology is available in the Stratos line in all colors.

Beauty.



TruTexture™ Surface

Our proprietary TruTexture coating utilizes advanced techniques to deliver lower pattern repetition, rich color variegation and a realistic wood grain texture in each decking board. And with added scratch resistance, you'll spend less time on maintenance and more time enjoying your backyard sanctuary.



Strength.



50% Greater Span

The strongest deck board in its class, providing greater rigidity and a more solid feel underfoot compared to conventional PVC and composite decking, even when installed 24" on center.



Stratos™

Composite Enhanced PVC Decking

Inspired. Resilient. Revolutionary.

Stratos composite enhanced PVC decking features our groundbreaking Next Core making our deck boards stronger and longer-spanning than any PVC decking on the market. Engineered with a 50% greater span to provide rigidity and a more solid feel, Stratos features our TruTexture Surface for a true wood grain finish. With CoolDeck Technology reducing heat up to 35%* and a proprietary acrylic cap providing a strong defense against stains, scratches and impact.

* Compared to standard capped PVC composites in similar color.

- **Made in the USA**
- **20-Year Commercial Limited Structural Warranty and Transferable Limited Lifetime Residential Structural Warranty**
- **50-Year Fade** and Stain Warranty**
- **Approved for marine grade installation up to 24" on center**
- **Minimal flex at 16" on center**
- **1" x 5.5" boards available in 12', 16' and 20' lengths for grooved edge; 16' and 20' for solid edge**

**Fade up to 5 Delta E



**Proprietary
Next Core™**



**CoolDeck®
Technology**



**TruTexture™
Surface**



**50% Greater
Span**



**Slip
Resistance**





1" x 6" Grooved Edge Board
Actual Dimensions 1" x 5.5"
Lengths 12', 16', 20'



1" x 6" Solid Edge Board
Actual Dimensions 1" x 5.5"
Lengths 16', 20'



Fascia Board
Actual Dimensions 0.5" x 11.25"
Length 12'

Available Colors





Mykonos



Santorini



Athena

For color availability in your region, please contact your MoistureShield representative.



Stratos

The Solid Core Difference

MoistureShield offers the only wood composite boards in the industry that can be installed on the ground, in the ground or underwater without any structural performance issues. At the foundation of every board is our proprietary Solid Core — an impermeable barrier that fights damage from moisture, rot, insects and other harmful elements. Our core maintains its integrity even after ripping and cutting, mitigating warranty issues and long-term damage.

Choose Solid Core and create outdoor spaces that stand up to the effects of weather and wear — day in and day out.



Wood fibers are individually encapsulated in plastic

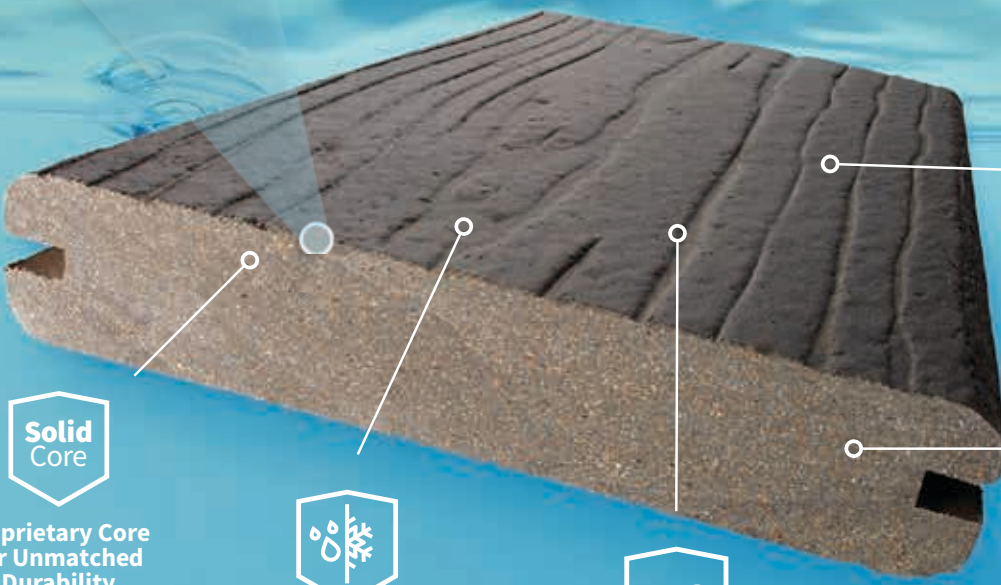

Proprietary Core for Unmatched Durability



No Warping or Rotting



Zero Structural Field Failures in 30+ Years



Virtually No Moisture Absorption



Resists Damage from Insects

Comfort.



CoolDeck® Technology

Finally, composite decking that stays comfortable all season long, when every degree counts. On a hot summer day, a deck can reach temperatures of more than 160°F. That's why we designed composite wood decking that helps reduce heat up to 35%*, staying cooler in extreme heat.

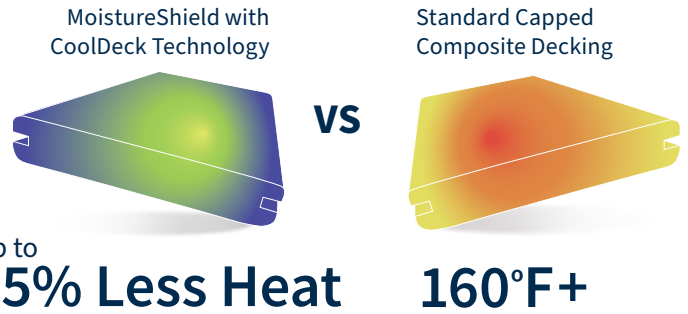

* Reduces heat absorption by up to 35% compared to standard capped composites in a similar color. CoolDeck Technology is available in select colors in the Vision and Meridian lines.

Durability.



DiamondDefense™ Coating

You choose composite decking to avoid maintenance like painting and staining, so why settle for products that scratch or chip on impact? Our DiamondDefense Coating creates the strongest capped wood composite board on the market to protect your deck against everyday damage to stay looking like new for longer.



Beauty.



TruTexture™ Surface

Our proprietary TruTexture coating utilizes advanced techniques to deliver lower pattern repetition, rich color variegation and a realistic wood grain texture in each composite decking board. And with added scratch resistance, you'll spend less time on maintenance and more time enjoying your backyard sanctuary.



Vision®

Capped Wood Composite Decking

Bold. Refined. Infinite.

Step up to the future of decking with our strongest capped wood composite board. Vision provides unbeatable moisture protection with our proprietary Solid Core Difference that enables our decking to be installed on the ground, in the ground or underwater by creating an impermeable barrier that also fights damage from rot, insects and other harmful elements. With our exclusive DiamondDefense Coating that resists scratches, stains and fading, Vision deck boards also feature CoolDeck Technology that reduces heat absorption up to 35%.* Choose from beautiful colors and textures that reflect the look of real hardwood while ensuring unmatched performance that is designed to last a lifetime.

* Reduces heat absorption by up to 35% compared to standard capped composites in a similar color.

- **Made in the USA with 95% recycled material**
- **20-Year Commercial Limited Structural Warranty and Transferable 50-Year Residential Structural Warranty**
- **50-Year Fade** and Stain Warranty**
- **2" x 6" Marine Grade Option Spans 24"**
- **Approved for use as cladding**
- **1" x 6" boards available in 12', 16' and 20' lengths available in solid and grooved edges**
- **Approved for use in California Wildland Urban Interface (WUI) zones (WUI Listing No. 8110-2321:0500)**

**Fade up to 5 Delta E



**Proprietary
Solid Core**



**CoolDeck®
Technology**



**Zero Structural Field
Failures in 30+ Years**



**DiamondDefense™
Coating**



**Slip
Resistance**



Available Colors



1" x 6" Grooved Edge Board

Actual Dimensions 1" x 5.4"
Lengths 12', 16', 20'



1" x 6" Solid Edge Board

Actual Dimensions 1" x 5.4"
Lengths 12', 16', 20' (12' CoolDeck
Colors only)
See page 24 for Marine Grade options



Fascia Board

Actual Dimensions 0.67" x 11.25"
Length 12'

COOLDECK
TECHNOLOGY



Cathedral Stone

Smokey Gray



Cold Brew

Spanish Leather



Mochaccino

Sandstone

For color availability in your region, please contact your MoistureShield representative.



Vision

Cold Brew

17

Meridian™

Capped Wood Composite Decking

Natural. Lasting. True.

Create the perfect escape — a composite deck featuring an authentic wood grain texture that doesn't require all the upkeep of real wood. Meridian provides unbeatable moisture protection with our proprietary Solid Core Difference that enables our decking to be installed on the ground, in the ground or underwater by creating an impermeable barrier that also fights damage from rot, insects and other harmful elements. With a TruTexture Surface that delivers lower pattern repetition, rich color variegation and added scratch resistance, Meridian deck boards also feature CoolDeck Technology that reduces heat absorption up to 35%.* Experience the beauty of a sanctuary that is designed to last a lifetime.

* Reduces heat absorption by up to 35% compared to standard capped composites in a similar color.

- **Made in the USA with 95% recycled material**
- **20-Year Commercial Limited Structural Warranty and Transferable 50-Year Residential Structural Warranty**
- **40-Year Fade** and Stain Warranty**
- **Approved for use as cladding**
- **1" x 6" boards available in 12', 16' and 20' lengths**
- **Available in solid and grooved edges**
- **Approved for use in California Wildland Urban Interface (WUI) zones (WUI Listing No. 8110-2321:0500)**

**Fade up to 5 Delta E



Proprietary Solid Core



Zero Structural Field Failures in 30+ Years



TruTexture™ Surface



CoolDeck® Technology



Slip Resistance

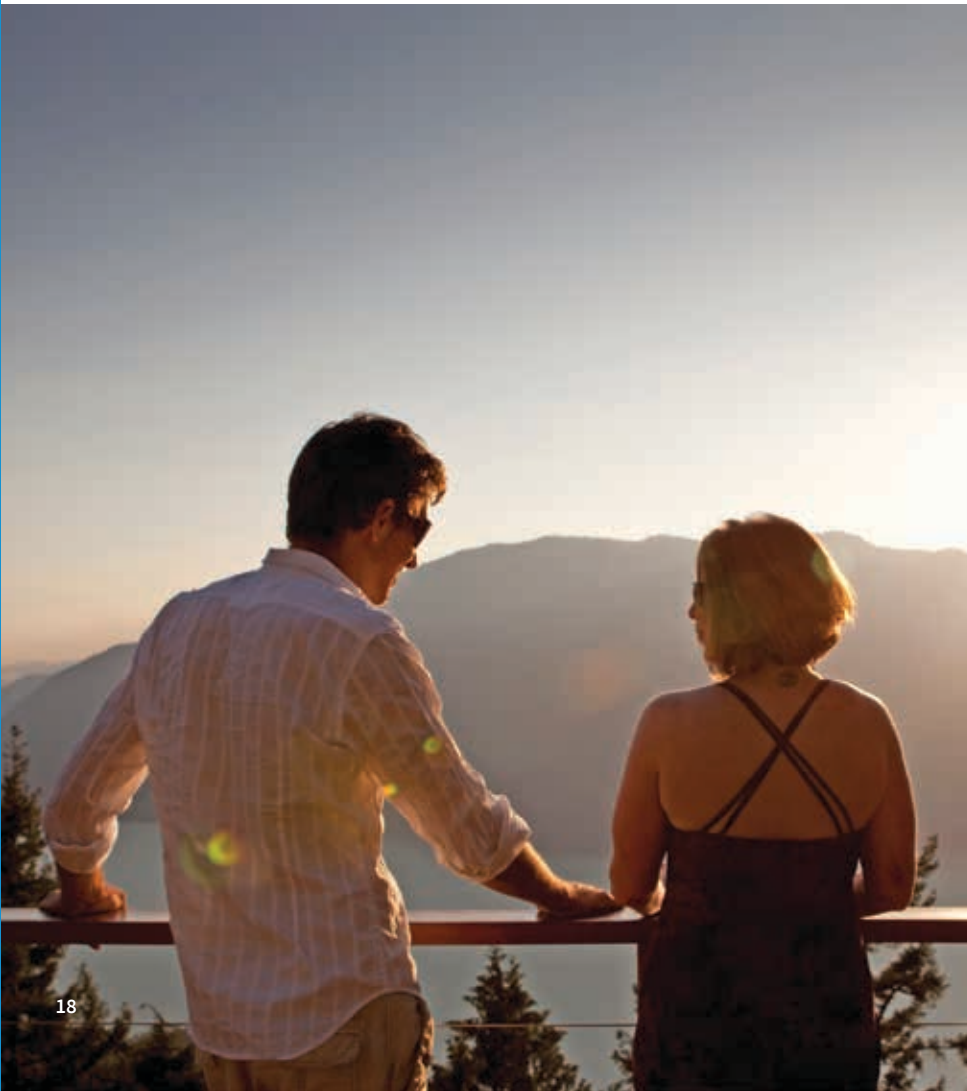



1" x 6" Grooved Edge Board
Actual Dimensions 1" x 5.4"
Lengths 12', 16', 20'



1" x 6" Solid Edge Board
Actual Dimensions 1" x 5.4"
Lengths 12', 16', 20'



Fascia Board
Actual Dimensions 0.67" x 11.25"
Length 12'

Available Colors

For color availability in your region, please contact your MoistureShield representative.



Meridian

Elevate™

Capped Wood Composite Decking

Strong. Dynamic. Fundamental.

Get advanced protection and beauty at a great value with our introductory capped wood composite board. Elevate provides unbeatable moisture protection with our proprietary Solid Core Difference that enables our decking to be installed on the ground, in the ground or underwater by creating an impermeable barrier that also fights damage from rot, insects and other harmful elements. Available in a curated selection of classic and premium colors with variegation for added texture and depth, Elevate composite decking allows you to create a stylish, durable outdoor environment simply and affordably.

- **Made in the USA with 95% recycled material**
- **20-Year Commercial Limited Structural Warranty and Transferable 50-Year Residential Structural Warranty**
- **30-Year Fade* and Stain Warranty**
- **Great value board**
- **1" x 6" boards available in 12', 16' and 20' lengths**
- **Available in solid and grooved edges**

*Fade up to 5 Delta E



**Proprietary
Solid Core**



**Zero Structural Field
Failures in 30+ Years**



**Slip
Resistance**





1" x 6" Grooved Edge Board
Actual Dimensions 1" x 5.4"
Lengths 12', 16', 20'



1" x 6" Solid Edge Board
Actual Dimensions 1" x 5.4"
Length 20'



Fascia Board
Actual Dimensions 0.67" x 11.25"
Length 12'

Available Colors



Lake Fog



Canoe



Alpine Gray



Riverbank

For color availability in your region, please contact your MoistureShield representative.



Elevate

Vantage™

Wood Composite Decking

Versatile. Durable. Dependable.

Our uncapped composite board, Vantage, performs like real wood — cutting, ripping and bending while still maintaining its integrity.* Providing unbeatable moisture protection with our proprietary Solid Core Difference that enables our decking to be installed on the ground, in the ground or underwater by creating an impermeable barrier that also fights damage from rot, insects and other harmful elements, Vantage deck boards are engineered to ensure protection without a cap. With self-healing properties that help minimize the appearance of scuffs and scratches, Vantage reversible boards feature the same wood grain texture on both sides for easier installation.

*Due to high wood fiber content and uncapped construction, Vantage boards will weather and lighten in color just like authentic wood decking.

- **Made in the USA with 95% recycled material**
- **20-Year Commercial Limited Structural Warranty and Transferable 50-Year Residential Structural Warranty**
- **Matte finish**
- **1" x 6" boards available in 12', 16' and 20' lengths**
- **2" x 6" and 2" x 8" Marine Grade Options Span 24"**
- **Available in solid and grooved edges**



**Proprietary
Solid Core**



**Zero Structural Field
Failures in 30+ Years**



**Reversible
Boards**



**Self-Healing
Boards**



**Slip
Resistance**





1" x 6" Grooved Edge Board
Actual Dimensions 1" x 5.4"
Lengths 12', 16', 20'



1" x 6" Solid Edge Board
Actual Dimensions 1" x 5.4"
Lengths 12', 16', 20'
See page 24 for Marine Grade options



Fascia Board
Actual Dimensions 0.67" x 11.25"
Length 12'

Available Colors[‡]

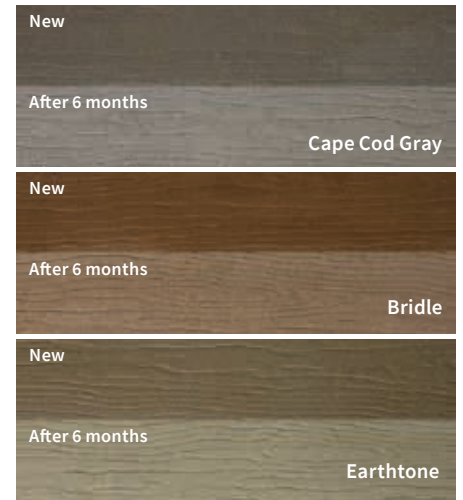

[‡] Vantage boards will naturally lighten to their permanent color within the first six months. Reference these swatches to ensure you'll love the end result.

For color availability in your region, please contact your MoistureShield representative.



Vantage

Marine Grade 2x

For Life on the Water.

Thicker 2x construction for docks, piers, marinas and more.

MoistureShield is the only wood composite decking on the market with virtually no moisture absorption, inside or out. Thanks to the Solid Core Difference, our products can be installed on the water or underwater without damage from warping or swelling, even after cutting. Get all the incredible advantages of our Vision and Vantage boards in a thicker 2x construction for all marine grade applications.



**Proprietary
Solid Core**



**Zero Structural Field
Failures in 30+ Years**



**Slip
Resistance**



**Marine Grade
Spans 24"**





Marine Grade

Vision Marine Grade 2x

For Life on the Water

Vision Marine Grade 2x — our strongest capped wood composite board rated for a 24" joist span — provides unbeatable moisture protection with virtually no moisture absorption, inside or out. Our proprietary Solid Core Difference enables our decking to be installed on the water or underwater without warping or swelling. With our exclusive DiamondDefense Coating that resists scratches, stains and fading, Vision Marine Grade 2x deck boards also feature CoolDeck Technology that reduces heat absorption up to 35%.*

* Reduces heat absorption by up to 35% compared to standard capped composites in a similar color.

- **Extremely durable — resistant to fading and swelling**
- **20-Year Commercial Limited Structural Warranty and Transferable 50-Year Residential Structural Warranty**
- **50-Year Fade** and Stain Warranty**

** Fade up to 5 Delta E



Proprietary Solid Core



Zero Structural Field Failures in 30+ Years



CoolDeck® Technology



DiamondDefense™ Coating



Marine Grade Spans 24"



Slip Resistance





2\"/>



Fascia Board
 Actual Dimensions 0.67\"/>

Available Colors

COOLDECK[®]
TECHNOLOGY

Cathedral Stone

Cold Brew

Mochaccino

For color availability in your region, please contact your MoistureShield representative.



Vision

Vantage Marine Grade 2x

For Life on the Water

Vantage Marine Grade 2x — our uncapped composite board rated for a 24" joist span — performs like real wood while still maintaining its integrity.* Providing unbeatable moisture protection with virtually no moisture absorption, inside or out. Our proprietary Solid Core Difference enables our decking to be installed on the water or underwater without warping or swelling. Vantage Marine Grade 2x deck boards are engineered to ensure protection without a cap, feature self-healing properties that help minimize the appearance of scuffs and scratches along with reversible boards that offer the same wood grain texture on both sides for easier installation.

*Due to high wood fiber content and uncapped construction, Vantage Marine Grade 2x boards will weather and lighten in color just like authentic wood decking.

- **No staining or sealing required**
- **Works like real wood**
- **50-Year Structural Warranty**



**Proprietary
Solid Core**



**Zero Structural Field
Failures in 30+ Years**



**Self-Healing
Boards**



**Reversible
Boards**



**Marine Grade
Spans 24"**



**Slip
Resistance**

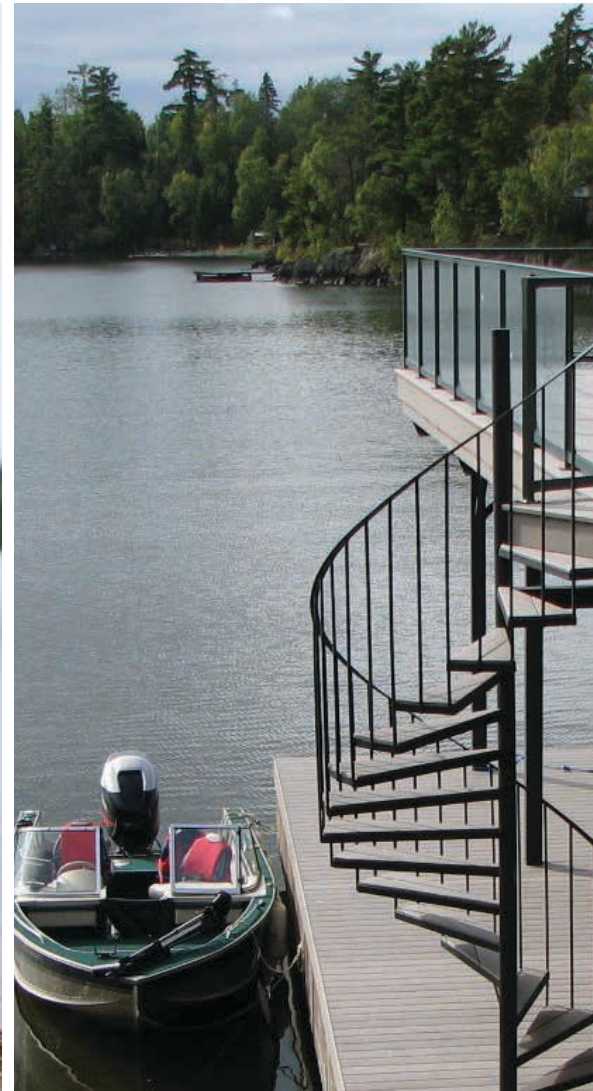



2" Solid Edge Deck Board

2" x 4" — actual dimensions 1.5" x 3.5" — available in 16'
 2" x 6" — actual dimensions 1.4" x 5.4" — available in 12', 16' and 20'
 2" x 8" — actual dimensions 1.4" x 7.25" — available in 12', 16' and 20**

* 2" x 4" is rated for 16" joist span
 ** 2" x 8" available in Cape Cod Gray only



Fascia Board

Actual Dimensions 0.67" x 11.25"
 Length 12'

Available Colors[‡]

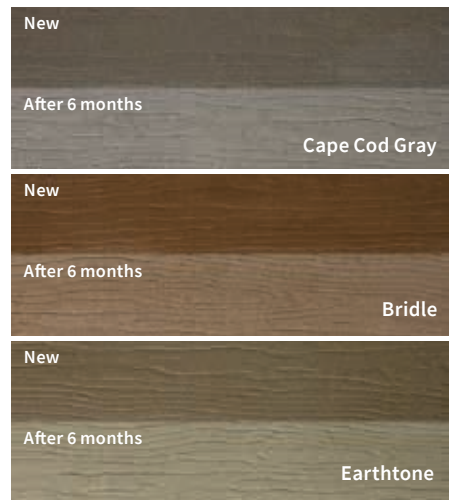

[‡] Vantage boards will naturally lighten to their permanent color within the first six months. Reference these swatches to ensure you'll love the end result.

For color availability in your region, please contact your MoistureShield representative.



Vantage



Stratos

Vision

Vision Marine Grade 2x

Board Composition

Next Core

Solid Core

Solid Core

Surface

TruTexture

DiamondDefense

DiamondDefense

CoolDeck Technology*



Reversible Board

—

—

—

Workability of Real Wood

—

—

—

Self-Healing

—

—

—

Grooved Edge or Solid

Both

Both

Solid

95% Recycled Content

—



Residential Structural
Warranty

Limited Lifetime

50-Year

50-Year

Commercial Structural
Warranty

20-Year

20-Year

20-Year

Fade and Stain Warranty

50-Year

50-Year

50-Year

Price Range

\$\$\$\$\$

\$\$\$\$

\$\$\$\$

Spans Up To

24"

16"

24"

Cladding Approved

—



—

*CoolDeck Technology is available in Stratos and select colors in the Vision and Meridian lines.



Meridian

Elevate

Vantage

Vantage Marine Grade 2x

Solid Core

Solid Core

Solid Core

Solid Core

TruTexture

Traditional Cap

Uncapped

Uncapped



—

—

—

—

—



—

—



—

—



Both

Both

Both

Solid



50-Year

50-Year

50-Year

50-Year

20-Year

20-Year

20-Year

20-Year

40-Year

30-Year

—

—

\$\$\$

\$

\$\$

\$\$

16"

16"

16"

24"



—

—

—

Cladding

Exterior Facade Options

Enhance the architectural detail of your facade while enjoying the benefits of a low maintenance material by using MoistureShield's Vision or Meridian composite decking for your cladding needs.

Our beautiful color options and textures reflect the look and feel of real hardwood, but have the performance of an impermeable barrier of wood fibers encapsulated in plastic.

MoistureShield is the only composite decking approved for cladding that offers 360-degree protection to the core to fight damage from moisture, rot, insects and the elements.

- **No warping or rotting**
- **Zero structural field failures in 30+ years**
- **Virtually no moisture absorption**
- **Resists damage from insects**
- **ICC-ES AC524 compliant**



Zero Structural Field Failures in 30+ Years



CoolDeck[®] Technology



Cladding

Exterior Facade Options

Our resilient, color-enriched composite cladding evokes the look and feel of real hardwood, with authentic wood grain textures and reduced pattern repetition. Except unlike real wood, composite cladding is made to withstand the elements, providing a natural look that doesn't require staining or painting.

And since MoistureShield Vision and Meridian composite decking is made with 95% recycled content, you are eligible to earn credit in LEED green building rating programs when using it in cladding applications — enabling you to make an environmental impact as well as an architectural statement.

Composite boards from both our Vision and Meridian product lines lend themselves to beautiful, durable exterior cladding installations.



For color availability in your region, please contact your MoistureShield representative.



Joist Tape

Added Protection for Longevity

When you choose deck boards protected with the Solid Core Difference, don't let your substructure go unprotected. Ensure every inch of your deck is designed to defy the elements with joist protection tape from MoistureShield. Its patented acrylic adhesive and woven cloth substrate create a tight seal over your deck joists and deck screws to prevent moisture infiltration. MoistureShield Joist Tape tears easily without tools, doesn't stick to itself and can be repositioned without leaving a residue, making it incredibly easy to work with on any substrate material — including lumber and steel.

MoistureShield Joist Tape is available in 2", 4" and 6" widths in 65' long rolls to accommodate your needs.

- Using deck joist tape adds up to 10+ years to the life of your deck
- Tears easily by hand without tools for easy handling on the job site
- Seals tightly around deck screws, preventing moisture infiltration and corrosion
- For application temperatures between -20°F to 200°F (-29°C and 93°C)

3 Sizes (available in black only):



2" Joist Tape
2" width x 65' length



4" Joist Tape
4" width x 65' length



6" Joist Tape
6" width x 65' length



MoistureShield Deck Clip

Metal Hidden Deck Fastener

Get the most seamless installation possible with our exclusive hidden fasteners. Designed specifically for our wood composite boards, these fasteners provide superior holding power that fits securely into grooved profiles. Hidden fasteners can even add to the life of your deck by elevating the boards off the joists to reduce structural rot and mold. They're backed by a Limited Lifetime Warranty against any loose deck boards.

Benefits of our hidden deck fasteners include:

- Easy to install with pneumatic fasteners or screws
- Concealed fasteners create an unblemished deck surface
- Allows joists to completely dry out — reducing structural rot or mold
- Powder coated high strength steel or stainless steel

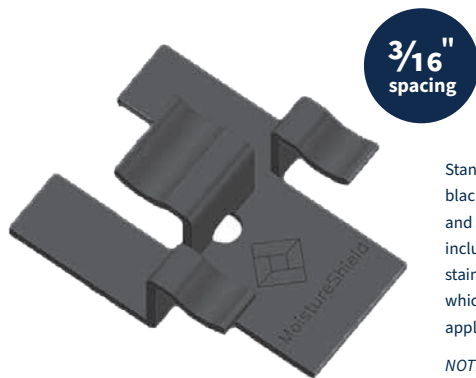

Standard Clip Packs include black-coated carbon steel clips and screws. Stainless steel kits include black-coated 304 grade stainless steel clips and screws which are approved for coastal applications.

NOTE: Traditional face screws can also be used.

Fastener Options:

Complete System: Covers 50 Square Feet of Decking

- Includes 90 clips, 5 starter clips, 5 finish clips and 100 screws
- Available in hand drive

Contractor Pack: Covers 250 Square Feet of Decking

- Includes 450 clips and 500 pneumatic nail screws
(Starter and finisher clips are sold separately)

Deck Clip Pack: Covers 250 Square Feet of Decking

- Includes 450 clips and 500 regular screws
(Starter and finisher clips are sold separately)

Starter Clip Pack: 25 Starter Clips with 25 Screws

- Starter clips are used to fasten the first deck board to the ledger board
(Estimated need for 250 square foot deck)

Finisher Clip Pack: 25 Finish Clips with 25 Screws

- Finish clips fasten the last deck boards
(Estimated need for 250 square foot deck)

Transition Clip Pack: 25 Transition Clips with 25 Screws

- Transition clips are used for picture frame decking and repair

For Installation: Hand Drive or Pneumatic Hidden Installation Tool



AEGIS◇CLIP™

Plastic Hidden Deck Fastener

MoistureShield's Aegis Clip offers a 90-degree installation process and fastener options designed to be used on wood or steel joist systems. The teeth on the bottom of the clip bite into the grooved deck board to help control lateral movement of the deck boards. Made from glass reinforced polypropylene for lasting strength and durability.

Benefits of the Aegis Clip deck fastener include:

- Concealed fasteners create an unblemished deck surface
- Beveled edges and pre-inserted screws for easy installation
- Clip teeth bite into the groove to help control lateral movement
- Approved for ACQ joists and all other PT joists

Fastener Options:

50 Square Foot Box

- Includes: 90 fasteners with pre-inserted screws, T-15 Star driver bit and instruction sheet

250 Square Foot Bucket

- Includes: 450 fasteners with pre-inserted screws, T-15 Star driver bit and instruction sheet

Stainless steel screws for wood and steel substructures available in both package sizes. Carbon steel screws for wood substructure available in both package sizes.

Clip Box and Bucket coverage based on 16" o.c. installation.



Lighting

Improved Safety and Ambiance

Solar post caps and a full LED lighting system are available for use with all MoistureShield railing products. Under-rail LED lighting strips feature an adhesive backing and easily connect with a 50W Bluetooth compatible transformer. Additional LED accessories include post caps, dome lights, flush deck and side/stair lights.

- **LED plug-and-play lighting system does not require cutting or splicing of wires**
- **Long-lasting, true white LED lights — rated at 50,000 hours**
- **Color matched post caps available for most railing styles**
- **Adjust and control lighting with smartphone***
- **Limited Warranty**

* Transformer is Bluetooth compatible; "SmartPower50" app available from the App Store and Google Play.

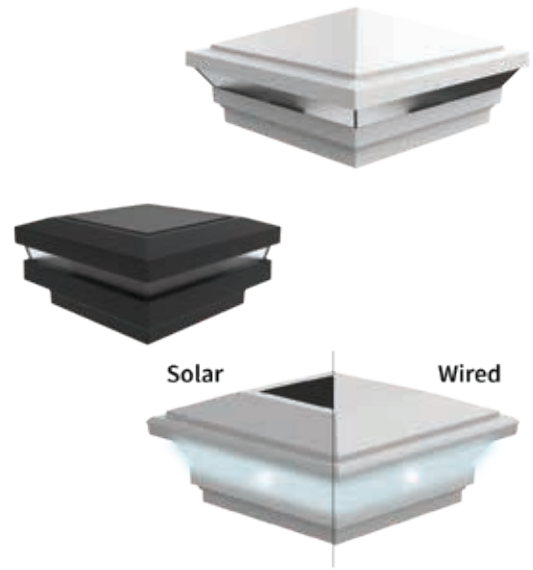



The Contractor Program that Grows with You

Choose a brand that's invested in your success. The MoistureShield Valued Partner (MVP) Program enables contractors to get exclusive access to product training, a preferred listing in our contractor database, direct support and more rewards.



LEARN

Arm yourself with comprehensive training and unlock exclusive selling resources. Plus and Premier level MVPs are backed by an exclusive labor warranty.

EARN

Enroll for free with Partner Rewards. MVPs earn bonus points toward gear when you buy MoistureShield decking, railing and other products from top building materials manufacturers.

GROW

Access business-building resources and marketing tips, and have a chance to be featured in our newsletter and get your projects professionally photographed. You'll also get a listing in our preferred contractor database, with exclusive priority for Plus and Premier MVPs.



| Benefits | \$0-\$24,999 in annual purchases | \$25,000-\$74,999 in annual purchases | \$75,000+ in annual purchases |
|--|-------------------------------------|--|--|
| Welcome Kit | Welcome Kit | Welcome Kit | Welcome Kit (+2 Premium Gear Choices) |
| Labor Warranty (after completed project inspection) | — | Up to 4 Years | Up to 7 Years |
| Marketing Funds | — | — | Yes |
| Listing on Find a Contractor | 3rd Priority | 2nd Priority | 1st Priority |
| Additional Requirements | MSU Online Certification | MSU Online Certification | MSU Online Certification |



Online Tools to Turn Your Dream Deck into Reality



How will I use the space? What are the best products for my needs and budget? How do I find a high-quality contractor? Where should I even start?

It's never been easier for homeowners to get started with the help of our new Outdoor Project Hub.

The Hub is an online tool to find inspiration, start planning with our project checklist, stay organized with our budget tracker and connect with trusted professionals (or DIY resources) to get the job done.

Are you ready to make your dream deck a reality? Visit ProjectHub.Moistureshield.com and start planning your project today!



Brands That Transform

MoistureShield is proudly part of the Oldcastle APG family of brands. Together these brands have everything to bring a backyard to life.





Discover More

Planning and inspiration tools at [MoistureShield.com](https://www.moistureshield.com)

Inspiration Gallery

A deck is not just an extension of your home, it's an extension of who you are and how you live. See what's possible and get inspired.

[MoistureShield.com/inspiration-gallery](https://www.moistureshield.com/inspiration-gallery)

Where to buy

Dealer Locator

Go online for a list of MoistureShield MVP retailers in your area.

Contractor Locator

Browse our list of MVP Contractors in your area to find the best contractor for your project.

Contact MoistureShield Customer Service at 866.729.2378 to find out how to be listed as an Authorized MoistureShield Dealer or Contractor.



Warranties

Our goal is to help you create worry-free outdoor living environments that stand strong and beautiful for years. All MoistureShield decking products offer commercial, residential and fade and stain warranties. Our railing products offer industry-leading warranties as well.

Make sure to register your deck and railing online for added peace of mind. Visit our website to explore our product warranties.

[MoistureShield.com/support/warranty](https://www.moistureshield.com/support/warranty)

Installation

Visit our website for instructions and installation tips.

[MoistureShield.com/support/installation-instructions](https://www.moistureshield.com/support/installation-instructions)

Care & Maintenance

MoistureShield decking is built with our proprietary Solid Core strength, and we've had zero structural failures in over 30 years.

Our decking and railing products are built to last. And, with basic care and maintenance, will keep looking like new for years to come.

Find detailed care and maintenance tips for your deck and railing on our website.

[MoistureShield.com/support/cleaning-care](https://www.moistureshield.com/support/cleaning-care)



