



TECH GUIDE

- | PWI 18S
- | PWI 20S
- | PWI 32S
- | PWI 36L
- | PWI 42S
- | PWI 52S
- | PWI 56L

PWT I-JOIST

RESIDENTIAL
CONSTRUCTION

PWT FOCUSED ON EWP





PWT™ I-Joists are straighter and more uniform in strength, stiffness and size than traditional lumber, providing a strong, sturdy floor. We offer longer lengths so that ceilings and floors can be designed with fewer pieces, saving time on installation. Other advantages over lumber include lower moisture content, which makes our I-Joists less likely to split, shrink, twist, warp or bow. This means reduced callbacks due to fewer pops and squeaks.

Strength in Numbers

The full range of PWT products are designed and manufactured to install easily and work together to provide a strong, sound structure.

For I-Joists, we combine laminated veneer lumber (LVL) or finger-jointed sawn lumber flanges with a web of oriented strand board (OSB) to produce an I-shaped structural member. The webs allow plumbing and wiring to pass through without extra framing, while the flanges resist bending – ideal for long spans in floors, ceilings and roofs.

PWT I-Joists are a building material with built-in environmental benefits

- Made of engineered wood substrate, a renewable resource with a reduced environmental impact
- Raw material procurement targets small, fast growing trees
- Only low-emitting, safe resins are used as a binder
- Available in longer lengths, reducing the number of pieces needed; this results in more efficient utilization of resources
- Can help you qualify for certification points in a number of leading green building programs

Peace-of-Mind for a Lifetime

If your PWT I-Joists ever develop performance problems due a manufacturing defect, PWT will cover all reasonable repair and/or replacement costs per the conditions of our Lifetime Limited Warranty. Visit pwtewp.com to view our complete warranty, or contact your local PWT distributor or sales office for an original copy.

Compliant with Major Building Codes

PWT I-Joists have been evaluated by CCMC for compliance with the National Building Code of Canada. Contact your local PWT distributor or visit pwtewp.com for the most current code reports.

Lifetime Limited Warranty

Products are backed by a lifetime limited warranty. Visit pwtewp.com or call (800) 515-7570 for a copy of the warranty.





I-Joists

PWI 18S / LPI 18

Width: 2-1/2"
Depths: 9-1/2", 11-7/8"
Web Thickness: 3/8"
Flange Material: Solid Sawn
Flange Depth: 1-1/2"

PWI 20S / LPI 20Plus

Width: 2-1/2"
Depths: 9-1/2", 11-7/8", 14", 16"
Web Thickness: 3/8"
Flange Material: Solid Sawn
Flange Depth: 1-1/2"

PWI 32S / LPI 32Plus

Width: 2-1/2"
Depths: 9-1/2", 11-7/8", 14", 16"
Web Thickness: 3/8"
Flange Material: Solid Sawn
Flange Depth: 1-1/2"

PWI 36L / LPI 36

Width: 2-1/4"
Depths: 11-7/8", 14", 16"
Web Thickness: 3/8"
Flange Material: LVL
Flange Depth: 1-1/2"

PWI 42S / LPI 42Plus

Width: 3-1/2"
Depths: 9-1/2", 11-7/8", 14", 16"
Web Thickness: 3/8"
Flange Material: Solid Sawn
Flange Depth: 1-1/2"

PWI 52S / LPI 52Plus

Width: 3-1/2"
Depths: 11-7/8", 14", 16"
Web Thickness: 7/16"
Flange Material: Solid Sawn
Flange Depth: 1-1/2"

PWI 56L / LPI 56

Width: 3-1/2"
Depths: 11-7/8", 14", 16"
Web Thickness: 7/16"
Flange Material: LVL
Flange Depth: 1-1/2"

Lengths: Up to 60'

Please verify availability with the PWT distributor in your area prior to specifying these products.

Code Evaluation Reports:
CCMC evaluation reports can be obtained at www.nrc-cnrc.gc.ca.

CCMC [12412-R](#), APA [PR-L238C](#)
or visit pwtewp.com

Product Specifications & Design Values

LIMIT STATES DESIGN VALUES

Series	Depth	Weight (plf)	Factored Moment (lb-ft)	EI (x 10 ⁶) (lb-in ²)	K (x 10 ⁶) (lb-ft/in)	Factored Shear (lbs)
PWI 18S, LPI 18	9-1/2"	2.6	3760	142	0.355	1785
	11-7/8"	2.9	4450	248	0.435	2105
PWI 20S, LPI 20PLUS	9-1/2"	2.6	4670	185	0.358	1990
	11-7/8"	2.9	6250	318	0.438	2345
	14"	3.1	7320	474	0.512	2650
PWI 32S, LPI 32PLUS	16"	3.3	8400	652	0.582	2950
	9-1/2"	2.6	5570	221	0.358	1990
	11-7/8"	2.9	7210	375	0.438	2345
PWI 36L, LPI 36	14"	3.1	8680	549	0.512	2650
	16"	3.3	10065	743	0.582	2950
	11-7/8"	3.1	10715	429	0.468	2550
PWI 42S, LPI 42PLUS	14"	3.4	12900	622	0.550	2890
	16"	3.6	14960	836	0.625	3190
	9-1/2"	3.4	8940	321	0.412	2115
PWI 52S, LPI 52PLUS	11-7/8"	3.5	11585	547	0.515	2565
	14"	3.8	13950	802	0.607	2960
	16"	4.0	16180	1092	0.693	3340
PWI 56L, LPI 56	11-7/8"	4.5	14085	600	0.633	3245
	14"	4.8	16960	874	0.747	3680
	16"	5.0	19670	1183	0.853	4080
PWI 56L, LPI 56	11-7/8"	4.5	16920	668	0.549	3245
	14"	4.8	20370	968	0.641	3680
	16"	5.0	23625	1301	0.729	4080

Notes:

- PWT I-Joists shall be designed for dry-use conditions only. Dry-use applies to products installed in dry, covered and well ventilated interior conditions in which the average equilibrium moisture content (MC) of lumber is 15% or less over a year and does not exceed 19% at any time.
- Moment and Shear are the factored resistances for standard load duration and shall be adjusted according to code.
- Moment resistance shall not be increased for repetitive member use.
- Deflection calculations shall include both bending and shear deformations.

Deflection for a simple span, uniform load:

$$\Delta = \frac{22.5wL^4}{EI} + \frac{wL^2}{K}$$

Where: Δ = deflection (in)
 w = uniform load (plf)
 L = design span (ft)
 EI = bending stiffness (from table)
 K = shear stiffness (from table)

Equations for other conditions can be found in engineering references.

FACTORED REACTION AND BEARING RESISTANCE

Series	Depth	End Reaction Resistance ¹ (lbs)				Interior Reaction Resistance ¹ (lbs)				Flange Bearing Resistance, ϕF_{cp} (lb/in)
		Minimum Bearing (1 1/2")		Maximum Bearing (4")		Minimum Bearing (3 1/2")		Maximum Bearing (5 1/2")		
		Without Stiffeners	With Stiffeners	Without Stiffeners	With Stiffeners	Without Stiffeners	With Stiffeners	Without Stiffeners	With Stiffeners	
PWI 18S, LPI 18	9-1/2"	1375	1620	1570	1785	3115	3370	3480	3740	1380
	11-7/8"	1375	1805	1640	2105	3305	3585	3685	4015	
PWI 20S, LPI 20PLUS	9-1/2"	1530	1800	1750	1990	3465	3750	3865	4160	1380
	11-7/8"	1530	2010	1830	2345	3680	3985	4095	4465	
	14"	1530	2200	1895	2650	3875	4205	4300	4745	
PWI 32S, LPI 32PLUS	16"	1530	2385	1955	2950	4055	4410	4500	5010	1695
	9-1/2"	1530	1800	1750	1990	3465	3750	3865	4160	
	11-7/8"	1530	2010	1830	2345	3680	3985	4095	4465	
PWI 36L, LPI 36	14"	1530	2200	1895	2650	3875	4205	4300	4745	1720
	16"	1530	2385	1955	2950	4055	4410	4500	5010	
	11-7/8"	1620	2370	2030	2550	3940	4900	4475	5475	
PWI 42S, LPI 42PLUS	14"	1620	2390	2090	2890	3940	5060	4475	5625	2450
	16"	1620	2405	2145	3190	3940	5215	4475	5770	
	9-1/2"	1870	2115	2060	2115	4575	4885	4640	5045	
PWI 52S, LPI 52PLUS	11-7/8"	1965	2385	2520	2565	4775	5270	4925	5550	2450
	14"	2050	2620	2520	2960	4955	5625	5175	6005	
	16"	2130	2840	2520	3340	5120	5960	5420	6440	
PWI 56L, LPI 56	11-7/8"	2160	2875	2670	3245	5400	6315	5740	6645	2720
	14"	2185	3110	2910	3680	5420	6725	5910	7165	
	16"	2210	3330	3135	4080	5445	7110	6075	7665	
PWI 56L, LPI 56	11-7/8"	1805	2620	2390	3245	4940	6090	5795	6410	2720
	14"	1805	2770	2425	3680	4940	6400	5795	6785	
	16"	1805	2910	2455	4080	4940	6700	5795	7140	

Notes:

- End and Interior Reaction Capacity shall be limited by the Flange Bearing Capacity or the bearing capacity of the support material, whichever is less.
- The Flange Bearing Capacity, per inch of bearing length, is based on the allowable compression perpendicular-to-grain of the I-Joist flange, accounting for eased edges.
- To account for edge easing when determining the bearing capacity of the support material, subtract 0.25" from the flange width for the PWI 18S, PWI 20S, PWI 32S, PWI 42S & PWI 52S; LPI 18, LPI 20PLUS, LPI 32PLUS, LPI 42PLUS & LPI 52PLUS, and subtract 0.10" from the flange width for the PWI 36L & PWI 56L; LPI 36 & LPI 56.
- Reaction Resistance, Flange Bearing Resistance and the bearing resistance of any wood support are for standard load duration and shall be reduced according to code for longer loading duration.
- Reaction Resistance and Flange Bearing Resistance may be increased over that tabulated for the minimum bearing length. Linear interpolation of the Reaction Resistance between the minimum and maximum bearing length is permitted. Bearing lengths longer than the maximum do not further increase Reaction Resistance. Flange Bearing Resistance and that of a wood support will increase with additional bearing length.
- The Interior Reaction Resistance may be calculated to a minimum bearing length of 3 inches, based on the 3-1/2" and 5-1/2" values.
- See page 25 for information on web stiffener sizes and nailing.

PROFILE DETAILS

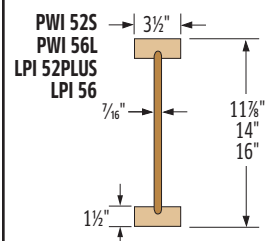
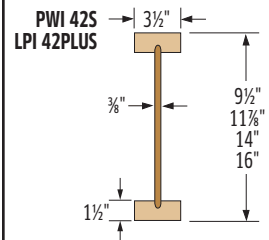
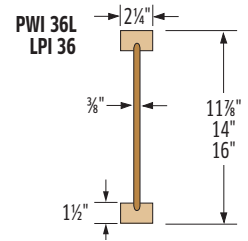
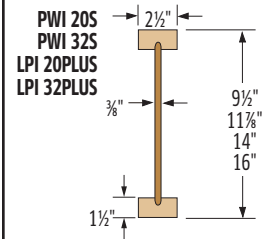
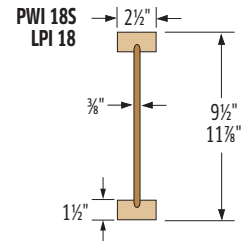

Example: Determine the stiffened end reaction capacity for a 14" PWI 32S with 2" of bearing for a non-snow roof load and supported on an SPF wall plate (768 psi).

- Determine End Reaction (ER) w/Stiffeners:
 $ER = 2200 + (2650 - 2200) \cdot (2" - 1.5") / (4" - 1.5") = 2290$ lbs
- Determine Flange Bearing Resistance (FBR):
 $FBR = 1695 \text{ lb/in} \cdot 2" = 3390$ lbs
- Determine wall Plate Bearing Resistance (PBR):
 $PBR = 0.8 \cdot 768 \text{ psi} \cdot (2.5" - 0.25") \cdot 2" = 2764$ lbs
- Final End Reaction Resistance w/Stiffeners = 2290 lbs

Floor Span Tables: 19/32 OSB Sheathing

Specified Floor Loads: 40 PSF Live Load, 15 PSF Dead Load

Table Usage:

1. Select the appropriate table based on the floor system construction.
2. Select the Simple Span or Continuous Span section of the table, as required.
3. Find a span that meets or exceeds the required clear span.
4. Read the corresponding joist series, depth and spacing.

Caution: For floor systems that require both simple span and continuous span joists, it is a good idea to check both before selecting a joist. Some conditions are controlled by continuous span rather than simple span.

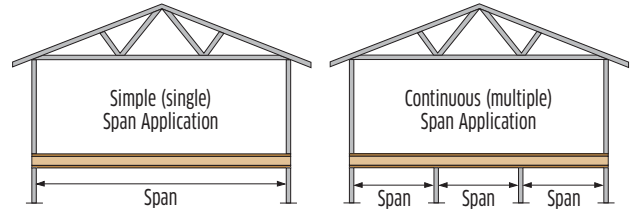

19/32 OSB SHEATHING NAILED ONLY

Series	Depth	No Direct Attached Ceiling						Direct Attached 1/2" Gypsum Ceiling					
		Maximum Simple Spans			Maximum Continuous Spans			Maximum Simple Spans			Maximum Continuous Spans		
		12" oc	16" oc	19.2" oc	12" oc	16" oc	19.2" oc	12" oc	16" oc	19.2" oc	12" oc	16" oc	19.2" oc
PWI 18S, LPI 18	9-1/2"	13'-6"	12'-7"	12'-1"	14'-0"	13'-0"	12'-6"	14'-0"	13'-0"	12'-6"	14'-5"	13'-5"	12'-11"
	11-7/8"	15'-4"	14'-4"	13'-9"	15'-10"	14'-9"	14'-2"	15'-10"	14'-9"	14'-2"	16'-5"	15'-3"	14'-8"
PWI 20S, LPI 20Plus	9-1/2"	14'-4"	13'-4"	12'-10"	14'-9"	13'-9"	13'-3"	14'-9"	13'-9"	13'-2"	15'-3"	14'-2"	13'-7"
	11-7/8"	16'-2"	15'-1"	14'-5"	16'-9"	15'-7"	14'-11"	16'-7"	15'-6"	14'-10"	17'-3"	16'-1"	15'-5"
	14"	17'-8"	16'-5"	15'-10"	18'-5"	17'-0"	16'-4"	18'-3"	16'-11"	16'-3"	19'-2"	17'-7"	16'-10"
PWI 32S, LPI 32Plus	9-1/2"	14'-10"	13'-10"	13'-3"	15'-4"	14'-4"	13'-9"	15'-3"	14'-2"	13'-7"	15'-9"	14'-8"	14'-1"
	11-7/8"	16'-9"	15'-7"	14'-11"	17'-4"	16'-1"	15'-6"	17'-2"	16'-0"	15'-4"	17'-10"	16'-7"	15'-11"
	14"	18'-3"	16'-11"	16'-3"	19'-2"	17'-7"	16'-10"	18'-11"	17'-5"	16'-9"	19'-11"	18'-2"	17'-4"
PWI 36L, LPI 36	11-7/8"	17'-3"	16'-1"	15'-5"	17'-10"	16'-7"	15'-11"	17'-8"	16'-6"	15'-9"	18'-6"	17'-1"	16'-4"
	14"	18'-11"	17'-5"	16'-9"	19'-11"	18'-2"	17'-4"	19'-7"	17'-11"	17'-2"	20'-7"	18'-10"	17'-10"
	16"	20'-8"	18'-10"	17'-11"	21'-8"	19'-9"	18'-9"	21'-4"	19'-6"	18'-6"	22'-5"	20'-6"	19'-6"
PWI 42S, LPI 42Plus	9-1/2"	16'-1"	15'-0"	14'-5"	16'-8"	15'-7"	14'-11"	16'-6"	15'-4"	14'-9"	17'-1"	15'-11"	15'-3"
	11-7/8"	18'-3"	16'-11"	16'-3"	19'-2"	17'-7"	16'-10"	18'-9"	17'-4"	16'-7"	19'-9"	18'-0"	17'-3"
	14"	20'-4"	18'-7"	17'-8"	21'-5"	19'-6"	18'-6"	21'-0"	19'-2"	18'-2"	22'-1"	20'-2"	19'-1"
PWI 52S, LPI 52Plus	11-7/8"	18'-10"	17'-5"	16'-8"	19'-9"	18'-1"	17'-4"	19'-5"	17'-9"	17'-1"	20'-4"	18'-7"	17'-8"
	14"	21'-0"	19'-3"	18'-3"	22'-1"	20'-2"	19'-2"	21'-7"	19'-9"	18'-9"	22'-9"	20'-9"	19'-9"
	16"	22'-11"	20'-11"	19'-11"	24'-1"	22'-0"	20'-11"	23'-7"	21'-7"	20'-6"	24'-10"	22'-8"	21'-6"
PWI 56L, LPI 56	11-7/8"	19'-3"	17'-8"	17'-0"	20'-3"	18'-6"	17'-7"	19'-10"	18'-1"	17'-4"	20'-10"	19'-0"	18'-1"
	14"	21'-5"	19'-7"	18'-7"	22'-7"	20'-7"	19'-6"	22'-1"	20'-2"	19'-2"	23'-2"	21'-2"	20'-1"
	16"	23'-4"	21'-4"	20'-3"	24'-7"	22'-5"	21'-3"	24'-0"	22'-0"	20'-10"	25'-3"	23'-1"	21'-11"

19/32 OSB SHEATHING GLUED & NAILED

Series	Depth	No Direct Attached Ceiling						Direct Attached 1/2" Gypsum Ceiling					
		Maximum Simple Spans			Maximum Continuous Spans			Maximum Simple Spans			Maximum Continuous Spans		
		12" oc	16" oc	19.2" oc	12" oc	16" oc	19.2" oc	12" oc	16" oc	19.2" oc	12" oc	16" oc	19.2" oc
PWI 18S, LPI 18	9-1/2"	14'-10"	14'-0"	13'-7"	15'-4"	14'-6"	14'-0"	15'-3"	14'-6"	14'-0"	15'-10"	15'-0"	14'-6"
	11-7/8"	16'-8"	15'-9"	15'-3"	17'-3"	16'-3"	15'-9"	17'-2"	16'-3"	15'-9"	17'-10"	16'-10"	16'-4"
PWI 20S, LPI 20Plus	9-1/2"	15'-5"	14'-7"	14'-1"	15'-11"	15'-0"	14'-7"	15'-11"	15'-0"	14'-6"	16'-5"	15'-6"	15'-0"
	11-7/8"	17'-4"	16'-4"	15'-10"	17'-11"	16'-11"	16'-4"	17'-10"	16'-10"	16'-3"	18'-8"	17'-5"	16'-10"
	14"	19'-1"	17'-9"	17'-2"	20'-0"	18'-7"	17'-10"	19'-10"	18'-6"	17'-9"	20'-10"	19'-4"	18'-7"
PWI 32S, LPI 32Plus	9-1/2"	15'-11"	15'-0"	14'-6"	16'-5"	15'-6"	15'-0"	16'-4"	15'-5"	14'-11"	16'-11"	15'-11"	15'-5"
	11-7/8"	17'-9"	16'-9"	16'-3"	18'-7"	17'-4"	16'-9"	18'-5"	17'-3"	16'-8"	19'-3"	17'-11"	17'-3"
	14"	19'-9"	18'-3"	17'-7"	20'-8"	19'-2"	18'-4"	20'-5"	19'-0"	18'-2"	21'-6"	19'-11"	19'-1"
PWI 36L, LPI 36	11-7/8"	18'-4"	17'-2"	16'-7"	19'-2"	17'-9"	17'-2"	18'-11"	17'-8"	17'-1"	19'-10"	18'-5"	17'-8"
	14"	20'-4"	18'-10"	18'-0"	21'-4"	19'-9"	18'-11"	21'-0"	19'-6"	18'-8"	22'-1"	20'-6"	19'-7"
	16"	22'-1"	20'-5"	19'-7"	23'-2"	21'-5"	20'-6"	22'-10"	21'-2"	20'-3"	24'-0"	22'-3"	21'-4"
PWI 42S, LPI 42Plus	9-1/2"	17'-0"	16'-0"	15'-5"	17'-7"	16'-6"	16'-0"	17'-4"	16'-4"	15'-10"	18'-1"	16'-11"	16'-4"
	11-7/8"	19'-4"	17'-11"	17'-4"	20'-4"	18'-9"	18'-0"	20'-0"	18'-6"	17'-9"	20'-11"	19'-5"	18'-7"
	14"	21'-7"	19'-11"	19'-1"	22'-7"	20'-11"	20'-0"	22'-3"	20'-7"	19'-8"	23'-4"	21'-7"	20'-8"
PWI 52S, LPI 52Plus	11-7/8"	19'-11"	18'-5"	17'-8"	20'-11"	19'-4"	18'-6"	20'-6"	19'-0"	18'-2"	21'-6"	19'-11"	19'-0"
	14"	22'-2"	20'-5"	19'-7"	23'-3"	21'-5"	20'-6"	22'-9"	21'-1"	20'-2"	23'-11"	22'-2"	21'-2"
	16"	24'-1"	22'-3"	21'-3"	25'-4"	23'-4"	22'-4"	24'-10"	22'-11"	21'-11"	26'-1"	24'-1"	23'-1"
PWI 56L, LPI 56	11-7/8"	20'-4"	18'-9"	17'-11"	21'-4"	19'-8"	18'-10"	20'-11"	19'-4"	18'-5"	21'-11"	20'-3"	19'-4"
	14"	22'-7"	20'-10"	19'-11"	23'-8"	21'-10"	20'-10"	23'-2"	21'-5"	20'-6"	24'-4"	22'-6"	21'-6"
	16"	24'-6"	22'-7"	21'-7"	25'-9"	23'-9"	22'-8"	23'-4"	22'-3"	21'-3"	26'-6"	24'-6"	23'-5"

Design Assumptions:

1. The spans listed are the clear distance between supports. Continuous spans are based on the longest span. The shortest span shall not be less than 50% of the longest span.
2. The spans are based on uniform floor loads only, for standard load duration.
3. These tables reflect the additional stiffness for vibration provided by a 19/32 OSB rated sheathing, or equal, attached as indicated (Nailed Only or Glued & Nailed) to the top flange.
4. Live load deflection is limited to L/360 "bare joist."
5. Total load deflection is limited to L/240.
6. The spans are based on an end bearing length of at least 1-3/4" and an interior bearing length of at least 3-1/2," and are limited to the bearing resistance of an SPF wall plate.

Additional Notes:

1. These spans have been designed to meet the Limit States Design and vibration requirements of the National Building Code of Canada.
2. Web stiffeners are not required for any of the spans in these tables.
3. Web fillers are required for I-Joists seated in hangers that do not laterally support the top flange.
4. For conditions not shown, use the Uniform Floor Load (PLF) tables, use the Exacte by PWT software or contact your PWT™ distributor for assistance.

Floor Span Tables: 23/32 OSB Sheathing

Specified Floor Loads: 40 PSF Live Load, 15 PSF Dead Load

Table Usage:

1. Select the appropriate table based on the floor system construction.
2. Select the Simple Span or Continuous Span section of the table, as required.
3. Find a span that meets or exceeds the required clear span.
4. Read the corresponding joist series, depth and spacing.

Caution: For floor systems that require both simple span and continuous span joists, it is a good idea to check both before selecting a joist. Some conditions are controlled by continuous span rather than simple span.

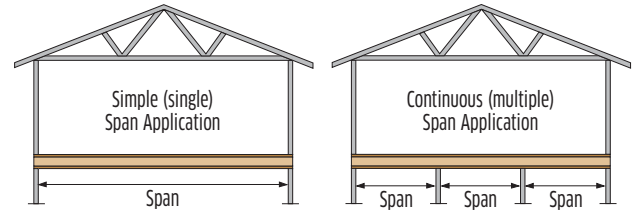

23/32 OSB SHEATHING NAILED ONLY

Series	Depth	No Direct Attached Ceiling								Direct Attached 1/2" Gypsum Ceiling							
		Maximum Simple Spans				Maximum Continuous Spans				Maximum Simple Spans				Maximum Continuous Spans			
		12" oc	16" oc	19.2" oc	24" oc	12" oc	16" oc	19.2" oc	24" oc	12" oc	16" oc	19.2" oc	24" oc	12" oc	16" oc	19.2" oc	24" oc
PWI 18S, LPI 18	9-1/2"	14'-2"	13'-3"	12'-8"	12'-0"	14'-8"	13'-8"	13'-1"	12'-5"	14'-7"	13'-7"	13'-0"	12'-4"	15'-1"	14'-1"	13'-5"	12'-9"
	11-7/8"	16'-1"	15'-0"	14'-4"	13'-8"	16'-8"	15'-6"	14'-10"	14'-1"	16'-6"	15'-5"	14'-9"	14'-0"	17'-1"	15'-11"	15'-3"	14'-6"
	14"	18'-8"	17'-3"	16'-6"	15'-8"	19'-7"	17'-11"	17'-1"	16'-3"	19'-3"	17'-8"	16'-11"	16'-1"	20'-3"	18'-6"	17'-7"	16'-9"
PWI 20S, LPI 20Plus	9-1/2"	15'-0"	14'-0"	13'-4"	12'-9"	15'-6"	14'-5"	13'-10"	13'-2"	15'-4"	14'-4"	13'-8"	13'-0"	15'-11"	14'-10"	14'-2"	13'-6"
	11-7/8"	16'-11"	15'-9"	15'-1"	14'-4"	17'-6"	16'-4"	15'-7"	14'-10"	17'-4"	16'-2"	15'-6"	14'-9"	18'-1"	16'-9"	16'-0"	15'-3"
	14"	18'-8"	17'-3"	16'-6"	15'-8"	19'-7"	17'-11"	17'-1"	16'-3"	19'-3"	17'-8"	16'-11"	16'-1"	20'-3"	18'-6"	17'-7"	16'-9"
PWI 32S, LPI 32Plus	9-1/2"	15'-7"	14'-6"	13'-10"	13'-2"	16'-1"	15'-0"	14'-4"	13'-8"	15'-11"	14'-10"	14'-2"	13'-6"	16'-6"	15'-4"	14'-8"	13'-11"
	11-7/8"	17'-6"	16'-4"	15'-7"	14'-10"	18'-3"	16'-11"	16'-2"	15'-4"	17'-11"	16'-9"	15'-2"	18'-10"	17'-4"	16'-7"	15'-9"	15'-9"
	14"	19'-5"	17'-9"	17'-0"	16'-2"	20'-5"	18'-7"	17'-7"	16'-9"	20'-0"	18'-4"	17'-5"	16'-7"	21'-0"	19'-3"	18'-2"	17'-2"
PWI 36L, LPI 36	11-7/8"	18'-1"	16'-10"	16'-1"	15'-4"	19'-0"	17'-5"	16'-8"	15'-10"	18'-7"	17'-2"	16'-5"	15'-8"	19'-6"	17'-10"	17'-1"	16'-3"
	14"	20'-2"	18'-5"	17'-6"	16'-8"	21'-2"	19'-4"	18'-3"	17'-3"	20'-9"	18'-11"	17'-11"	17'-0"	21'-9"	19'-11"	18'-10"	17'-8"
	16"	21'-11"	20'-0"	18'-11"	17'-9"	23'-0"	21'-0"	19'-10"	18'-7"	22'-7"	20'-8"	19'-6"	18'-4"	23'-8"	21'-8"	20'-6"	19'-3"
PWI 42S, LPI 42Plus	9-1/2"	16'-11"	15'-9"	15'-1"	14'-4"	17'-6"	16'-4"	15'-7"	14'-10"	17'-3"	16'-1"	15'-4"	14'-7"	17'-10"	16'-7"	15'-11"	15'-1"
	11-7/8"	19'-5"	17'-9"	17'-0"	16'-2"	20'-4"	18'-7"	17'-7"	16'-9"	19'-10"	18'-2"	17'-4"	16'-6"	20'-10"	19'-1"	18'-0"	17'-1"
	14"	21'-8"	19'-9"	18'-8"	17'-7"	22'-9"	20'-9"	19'-7"	18'-4"	22'-2"	20'-3"	19'-2"	18'-0"	23'-4"	21'-4"	20'-2"	18'-11"
PWI 52S, LPI 52Plus	11-7/8"	20'-0"	18'-4"	17'-5"	16'-7"	21'-0"	19'-2"	18'-2"	17'-2"	20'-6"	18'-9"	17'-9"	16'-11"	21'-6"	19'-8"	18'-7"	17'-6"
	14"	22'-4"	20'-5"	19'-3"	18'-1"	23'-5"	21'-5"	20'-3"	19'-0"	22'-10"	20'-11"	19'-9"	18'-7"	24'-0"	21'-11"	20'-9"	19'-6"
	16"	24'-4"	22'-3"	21'-0"	19'-9"	25'-7"	23'-4"	22'-1"	20'-9"	24'-11"	22'-10"	21'-7"	20'-3"	26'-2"	24'-0"	22'-8"	21'-3"
PWI 56L, LPI 56	11-7/8"	20'-6"	18'-8"	17'-9"	16'-10"	21'-6"	19'-8"	18'-7"	17'-6"	21'-0"	19'-2"	18'-1"	17'-2"	22'-0"	20'-1"	19'-0"	17'-10"
	14"	22'-10"	20'-10"	19'-8"	18'-5"	24'-0"	21'-10"	20'-8"	19'-4"	23'-4"	21'-4"	20'-2"	18'-11"	24'-6"	22'-5"	21'-2"	19'-10"
	16"	24'-10"	22'-8"	21'-4"	20'-1"	26'-1"	23'-10"	22'-6"	21'-1"	25'-5"	23'-3"	21'-11"	20'-7"	26'-8"	24'-5"	23'-1"	21'-8"

23/32 OSB SHEATHING GLUED & NAILED

Series	Depth	No Direct Attached Ceiling								Direct Attached 1/2" Gypsum Ceiling							
		Maximum Simple Spans				Maximum Continuous Spans				Maximum Simple Spans				Maximum Continuous Spans			
		12" oc	16" oc	19.2" oc	24" oc	12" oc	16" oc	19.2" oc	24" oc	12" oc	16" oc	19.2" oc	24" oc	12" oc	16" oc	19.2" oc	24" oc
PWI 18S, LPI 18	9-1/2"	15'-8"	14'-10"	14'-4"	13'-2"	16'-2"	15'-4"	14'-9"	13'-7"	16'-2"	15'-3"	14'-4"	13'-2"	16'-8"	15'-9"	15'-2"	13'-7"
	11-7/8"	17'-7"	16'-7"	16'-0"	14'-10"	18'-4"	17'-2"	16'-7"	14'-9"	18'-2"	17'-2"	16'-7"	14'-10"	19'-1"	17'-9"	16'-7"	14'-9"
	14"	19'-5"	17'-9"	17'-0"	16'-2"	20'-4"	18'-7"	17'-7"	16'-9"	19'-10"	18'-2"	17'-4"	16'-6"	20'-10"	19'-1"	18'-0"	17'-1"
PWI 20S, LPI 20Plus	9-1/2"	16'-4"	15'-4"	14'-10"	14'-3"	16'-10"	15'-11"	15'-4"	14'-8"	16'-9"	15'-10"	15'-3"	14'-5"	17'-4"	16'-4"	15'-9"	15'-2"
	11-7/8"	18'-4"	17'-3"	16'-7"	15'-11"	19'-3"	17'-10"	17'-2"	16'-6"	19'-0"	17'-9"	17'-1"	16'-5"	19'-11"	18'-6"	17'-8"	17'-0"
	14"	20'-6"	19'-0"	18'-1"	17'-4"	21'-5"	19'-11"	18'-11"	18'-0"	21'-2"	19'-8"	18'-10"	17'-10"	22'-3"	20'-8"	19'-9"	18'-9"
PWI 32S, LPI 32Plus	11-7/8"	16'-9"	15'-10"	15'-3"	14'-8"	17'-4"	16'-4"	15'-9"	15'-1"	17'-2"	16'-2"	15'-8"	15'-0"	17'-9"	16'-9"	16'-2"	15'-6"
	14"	19'-0"	17'-8"	17'-1"	16'-4"	19'-11"	18'-6"	17'-8"	16'-11"	19'-7"	18'-3"	17'-6"	16'-10"	20'-7"	19'-1"	18'-3"	17'-5"
	16"	21'-1"	19'-7"	18'-8"	17'-9"	22'-2"	20'-6"	19'-7"	18'-7"	21'-10"	20'-3"	19'-4"	18'-4"	22'-10"	21'-3"	20'-3"	19'-3"
PWI 36L, LPI 36	11-7/8"	19'-7"	18'-2"	17'-5"	16'-9"	20'-7"	19'-0"	18'-2"	17'-4"	20'-2"	18'-9"	17'-10"	17'-2"	21'-2"	19'-8"	18'-9"	17'-9"
	14"	21'-9"	20'-1"	19'-2"	18'-2"	22'-10"	21'-1"	20'-1"	19'-1"	22'-5"	20'-9"	19'-10"	18'-10"	23'-6"	21'-10"	20'-10"	19'-9"
	16"	23'-7"	21'-10"	20'-10"	19'-9"	24'-9"	22'-11"	21'-10"	19'-9"	24'-4"	22'-7"	21'-6"	20'-5"	25'-6"	23'-9"	22'-7"	19'-9"
PWI 42S, LPI 42Plus	9-1/2"	17'-11"	16'-10"	16'-3"	15'-7"	18'-9"	17'-5"	16'-9"	16'-1"	18'-4"	17'-2"	16'-7"	15'-10"	19'-3"	17'-10"	17'-2"	16'-5"
	11-7/8"	20'-9"	19'-2"	18'-3"	17'-5"	21'-9"	20'-1"	19'-1"	18'-1"	21'-3"	19'-8"	18'-9"	17'-10"	22'-4"	20'-8"	19'-8"	18'-8"
	14"	23'-0"	21'-3"	20'-3"	19'-2"	24'-2"	22'-4"	21'-3"	20'-2"	23'-8"	21'-11"	20'-10"	19'-9"	24'-10"	23'-0"	21'-11"	20'-9"
PWI 52S, LPI 52Plus	11-7/8"	21'-3"	19'-8"	18'-9"	17'-10"	22'-4"	20'-7"	19'-8"	18'-7"	21'-9"	20'-2"	19'-3"	18'-3"	22'-10"	21'-2"	20'-2"	19'-1"
	14"	23'-8"	21'-10"	20'-9"	19'-8"	24'-10"	22'-11"	21'-10"	20'-8"	24'-2"	22'-5"	21'-4"	20'-3"	25'-5"	23'-6"	22'-5"	21'-3"
	16"	25'-9"	23'-9"	22'-7"	21'-5"	27'-0"	24'-11"	23'-9"	22'-6"	26'-4"	24'-5"	23'-3"	22'-0"	27'-8"	25'-8"	24'-5"	23'-1"
PWI 56L, LPI 56	11-7/8"	21'-9"	20'-1"	19'-1"	18'-1"	22'-10"	21'-0"	20'-0"	18'-11"	22'-3"	20'-7"	19'-7"	18'-6"	23'-4"	21'-7"	20'-6"	19'-5"
	14"	24'-1"	22'-3"	21'-2"	20'-0"	25'-4"	23'-4"	22'-2"	21'-0"	24'-8"	22'-10"	21'-8"	20'-6"	25'-11"	23'-11"	22'-10"	21'-7"
	16"	26'-2"	24'-2"	22'-11"	21'-9"	27'-6"	25'-4"	24'-1"	22'-10"	26'-9"	24'-9"	23'-7"	22'-4"	28'-2"	26'-1"	24'-9"	23'-5"

Design Assumptions:

1. The spans listed are the clear distance between supports. Continuous spans are based on the longest span. The shortest span shall not be less than 50% of the longest span.
2. The spans are based on uniform floor loads only, for standard load duration.
3. These tables reflect the additional stiffness for vibration provided by a 23/32 OSB rated sheathing, or equal, attached as indicated (Nailed Only or Glued & Nailed) to the top flange.
4. Live load deflection is limited to L/360 "bare joist."
5. Total load deflection is limited to L/240.
6. The spans are based on an end bearing length of at least 1-3/4" and an interior bearing length of at least 3-1/2," and are limited to the bearing resistance of an SPF wall plate.

Additional Notes:

1. These spans have been designed to meet the Limit States Design and vibration requirements of the National Building Code of Canada.
2. Web stiffeners are not required for any of the spans in these tables.
3. Web fillers are required for I-Joists seated in hangers that do not laterally support the top flange.
4. For conditions not shown, use the Uniform Floor Load (PLF) tables, use the Exacte by PWT software or contact your PWT distributor for assistance.

Floor Span Tables: 5/8 OSB Sheathing

Specified Floor Loads: 40 PSF Live Load, 15 PSF Dead Load

Table Usage:

1. Select the appropriate table based on the floor system construction.
2. Select the Simple Span or Continuous Span section of the table, as required.
3. Find a span that meets or exceeds the required clear span.
4. Read the corresponding joist series, depth and spacing.

Caution: For floor systems that require both simple span and continuous span joists, it is a good idea to check both before selecting a joist. Some conditions are controlled by continuous span rather than simple span.

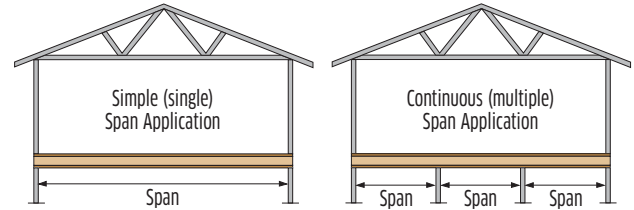

5/8 OSB SHEATHING NAILED ONLY

Series	Depth	No Direct Attached Ceiling						Direct Attached 1/2" Gypsum Ceiling					
		Maximum Simple Spans			Maximum Continuous Spans			Maximum Simple Spans			Maximum Continuous Spans		
		12" oc	16" oc	19.2" oc	12" oc	16" oc	19.2" oc	12" oc	16" oc	19.2" oc	12" oc	16" oc	19.2" oc
PWI 18S, LPI 18	9-1/2"	13'-9"	12'-9"	12'-3"	14'-2"	13'-2"	12'-8"	14'-1"	13'-2"	12'-7"	14'-7"	13'-7"	13'-0"
	11-7/8"	15'-6"	14'-6"	13'-11"	16'-1"	15'-0"	14'-4"	16'-0"	14'-11"	14'-4"	16'-7"	15'-5"	14'-10"
PWI 20S, LPI 20Plus	9-1/2"	14'-6"	13'-6"	12'-11"	15'-0"	13'-11"	13'-4"	14'-11"	13'-10"	13'-3"	15'-5"	14'-4"	13'-9"
	11-7/8"	16'-4"	15'-3"	14'-7"	16'-11"	15'-9"	15'-1"	16'-10"	15'-8"	15'-0"	17'-5"	16'-3"	15'-7"
	14"	17'-11"	16'-8"	16'-0"	18'-9"	17'-3"	16'-6"	18'-6"	17'-2"	16'-5"	19'-5"	17'-9"	17'-0"
PWI 32S, LPI 32Plus	9-1/2"	15'-1"	14'-0"	13'-5"	15'-7"	14'-6"	13'-11"	15'-5"	14'-4"	13'-9"	16'-0"	14'-10"	14'-3"
	11-7/8"	16'-11"	15'-9"	15'-1"	17'-6"	16'-4"	15'-8"	17'-4"	16'-2"	15'-6"	18'-1"	16'-9"	16'-1"
	14"	18'-7"	17'-2"	16'-5"	19'-6"	17'-10"	17'-1"	19'-3"	17'-8"	16'-11"	20'-2"	18'-5"	17'-6"
PWI 36L, LPI 36	11-7/8"	17'-5"	16'-3"	15'-7"	18'-2"	16'-10"	16'-1"	17'-10"	16'-8"	15'-11"	18'-9"	17'-3"	16'-6"
	14"	19'-3"	17'-8"	16'-11"	20'-3"	18'-6"	17'-7"	19'-11"	18'-2"	17'-4"	20'-11"	19'-1"	18'-1"
	16"	21'-0"	19'-2"	18'-2"	22'-0"	20'-1"	19'-1"	21'-8"	19'-10"	18'-9"	22'-9"	20'-10"	19'-9"
PWI 42S, LPI 42Plus	9-1/2"	16'-4"	15'-2"	14'-7"	16'-11"	15'-9"	15'-1"	16'-8"	15'-7"	14'-11"	17'-3"	16'-1"	15'-5"
	11-7/8"	18'-7"	17'-2"	16'-5"	19'-6"	17'-9"	17'-0"	19'-1"	17'-6"	16'-10"	20'-0"	18'-3"	17'-5"
	14"	20'-8"	18'-11"	17'-11"	21'-9"	19'-10"	18'-10"	21'-3"	19'-5"	18'-5"	22'-4"	20'-5"	19'-4"
PWI 52S, LPI 52Plus	11-7/8"	19'-2"	17'-7"	16'-11"	20'-1"	18'-4"	17'-6"	19'-8"	18'-0"	17'-3"	20'-8"	18'-11"	17'-11"
	14"	21'-4"	19'-6"	18'-6"	22'-5"	20'-6"	19'-5"	21'-11"	20'-1"	19'-0"	23'-0"	21'-1"	20'-0"
	16"	23'-4"	21'-3"	20'-2"	24'-6"	22'-4"	21'-2"	23'-11"	21'-11"	20'-9"	25'-2"	23'-0"	21'-10"
PWI 56L, LPI 56	11-7/8"	19'-7"	17'-11"	17'-2"	20'-7"	18'-9"	17'-10"	20'-1"	18'-4"	17'-6"	21'-2"	19'-4"	18'-3"
	14"	21'-10"	19'-11"	18'-10"	22'-11"	20'-11"	19'-10"	22'-5"	20'-5"	19'-4"	23'-6"	21'-6"	20'-4"
	16"	23'-9"	21'-8"	20'-6"	25'-0"	22'-9"	21'-7"	24'-5"	22'-3"	21'-1"	25'-8"	23'-5"	22'-2"

5/8 OSB SHEATHING GLUED & NAILED

Series	Depth	No Direct Attached Ceiling						Direct Attached 1/2" Gypsum Ceiling					
		Maximum Simple Spans			Maximum Continuous Spans			Maximum Simple Spans			Maximum Continuous Spans		
		12" oc	16" oc	19.2" oc	12" oc	16" oc	19.2" oc	12" oc	16" oc	19.2" oc	12" oc	16" oc	19.2" oc
PWI 18S, LPI 18	9-1/2"	15'-0"	14'-3"	13'-9"	15'-6"	14'-8"	14'-2"	15'-6"	14'-8"	14'-2"	16'-0"	15'-2"	14'-8"
	11-7/8"	16'-11"	16'-0"	15'-5"	17'-6"	16'-6"	16'-0"	17'-5"	16'-6"	16'-0"	18'-2"	17'-1"	16'-6"
PWI 20S, LPI 20Plus	9-1/2"	15'-8"	14'-9"	14'-3"	16'-2"	15'-3"	14'-9"	16'-1"	15'-2"	14'-8"	16'-8"	15'-9"	15'-2"
	11-7/8"	17'-7"	16'-7"	16'-0"	18'-3"	17'-2"	16'-7"	18'-1"	17'-1"	16'-6"	19'-0"	17'-8"	17'-1"
	14"	19'-6"	18'-1"	17'-5"	20'-5"	18'-11"	18'-1"	20'-2"	18'-9"	18'-0"	21'-2"	19'-8"	18'-10"
PWI 32S, LPI 32Plus	9-1/2"	16'-1"	15'-2"	14'-8"	16'-8"	15'-8"	15'-2"	16'-6"	15'-7"	15'-1"	17'-1"	16'-2"	15'-7"
	11-7/8"	18'-1"	17'-0"	16'-5"	18'-11"	17'-7"	17'-0"	18'-8"	17'-6"	16'-11"	19'-7"	18'-3"	17'-6"
	14"	20'-1"	18'-7"	17'-10"	21'-1"	19'-6"	18'-8"	20'-10"	19'-4"	18'-6"	21'-10"	20'-3"	19'-5"
PWI 36L, LPI 36	11-7/8"	18'-8"	17'-5"	16'-10"	19'-7"	18'-1"	17'-5"	19'-3"	17'-10"	17'-3"	20'-2"	18'-9"	17'-11"
	14"	20'-8"	19'-2"	18'-4"	21'-8"	20'-1"	19'-2"	21'-4"	19'-10"	18'-11"	22'-5"	20'-10"	19'-11"
	16"	22'-6"	20'-10"	19'-11"	23'-7"	21'-10"	20'-10"	23'-3"	21'-7"	20'-7"	24'-5"	22'-8"	21'-8"
PWI 42S, LPI 42Plus	9-1/2"	17'-3"	16'-2"	15'-8"	17'-10"	16'-9"	16'-2"	17'-7"	16'-7"	16'-0"	18'-4"	17'-2"	16'-7"
	11-7/8"	19'-9"	18'-3"	17'-6"	20'-8"	19'-1"	18'-3"	20'-4"	18'-9"	17'-11"	21'-4"	19'-9"	18'-10"
	14"	21'-11"	20'-3"	19'-4"	23'-0"	21'-3"	20'-4"	22'-7"	20'-11"	19'-11"	23'-9"	21'-11"	21'-0"
PWI 52S, LPI 52Plus	11-7/8"	20'-3"	18'-9"	17'-11"	21'-3"	19'-8"	18'-9"	20'-10"	19'-3"	18'-5"	21'-10"	20'-3"	19'-4"
	14"	22'-6"	20'-10"	19'-10"	23'-8"	21'-10"	20'-10"	23'-2"	21'-5"	20'-5"	24'-4"	22'-6"	21'-6"
	16"	24'-6"	22'-8"	21'-7"	25'-9"	23'-9"	22'-8"	25'-2"	23'-4"	22'-3"	26'-6"	24'-6"	23'-5"
PWI 56L, LPI 56	11-7/8"	20'-8"	19'-1"	18'-3"	21'-9"	20'-0"	19'-1"	21'-3"	19'-7"	18'-9"	22'-3"	20'-7"	19'-8"
	14"	22'-11"	21'-2"	20'-2"	24'-1"	22'-3"	21'-2"	23'-7"	21'-9"	20'-9"	24'-9"	22'-11"	21'-10"
	16"	24'-11"	23'-0"	21'-11"	26'-3"	24'-2"	23'-0"	25'-7"	23'-8"	22'-7"	26'-11"	24'-11"	23'-9"

Design Assumptions:

1. The spans listed are the clear distance between supports. Continuous spans are based on the longest span. The shortest span shall not be less than 50% of the longest span.
2. The spans are based on uniform floor loads only, for standard load duration.
3. These tables reflect the additional stiffness for vibration provided by a 5/8 OSB rated sheathing, or equal, attached as indicated (Nailed Only or Glued & Nailed) to the top flange.
4. Live load deflection is limited to L/360 "bare joist."
5. Total load deflection is limited to L/240.
6. The spans are based on an end bearing length of at least 1-3/4" and an interior bearing length of at least 3-1/2," and are limited to the bearing resistance of an SPF wall plate.

Additional Notes:

1. These spans have been designed to meet the Limit States Design and vibration requirements of the National Building Code of Canada.
2. Web stiffeners are not required for any of the spans in these tables.
3. Web fillers are required for I-Joists seated in hangers that do not laterally support the top flange.
4. For conditions not shown, use the Uniform Floor Load (PLF) tables, use the Exacte by PWT software or contact your PWT™ distributor for assistance.

Floor Span Tables: 3/4 OSB Sheathing

Specified Floor Loads: 40 PSF Live Load, 15 PSF Dead Load

Table Usage:

1. Select the appropriate table based on the floor system construction.
2. Select the Simple Span or Continuous Span section of the table, as required.
3. Find a span that meets or exceeds the required clear span.
4. Read the corresponding joist series, depth and spacing.

Caution: For floor systems that require both simple span and continuous span joists, it is a good idea to check both before selecting a joist. Some conditions are controlled by continuous span rather than simple span.

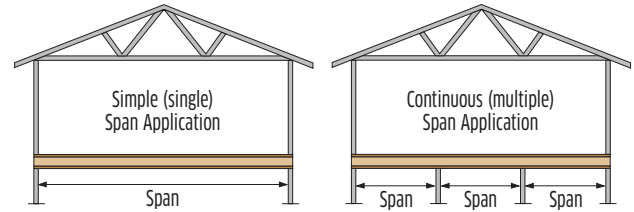

3/4 OSB SHEATHING NAILED ONLY

Series	Depth	No Direct Attached Ceiling								Direct Attached 1/2" Gypsum Ceiling							
		Maximum Simple Spans				Maximum Continuous Spans				Maximum Simple Spans				Maximum Continuous Spans			
		12" oc	16" oc	19.2" oc	24" oc	12" oc	16" oc	19.2" oc	24" oc	12" oc	16" oc	19.2" oc	24" oc	12" oc	16" oc	19.2" oc	24" oc
PWI 18S, LPI 18	9-1/2"	14'-4"	13'-4"	12'-9"	12'-2"	14'-10"	13'-10"	13'-2"	12'-6"	14'-9"	13'-9"	13'-2"	12'-6"	15'-3"	14'-2"	13'-7"	12'-11"
	11-7/8"	16'-3"	15'-2"	14'-6"	13'-9"	16'-10"	15'-8"	15'-0"	14'-3"	16'-8"	15'-7"	14'-11"	14'-2"	17'-3"	16'-1"	15'-5"	14'-8"
	14"	18'-11"	17'-5"	16'-8"	15'-10"	19'-10"	18'-2"	17'-3"	16'-5"	19'-6"	17'-11"	17'-1"	16'-3"	20'-6"	18'-9"	17'-9"	16'-10"
PWI 20S, LPI 20Plus	9-1/2"	15'-2"	14'-2"	13'-6"	12'-10"	15'-8"	14'-7"	13'-11"	13'-3"	15'-6"	14'-6"	13'-10"	13'-2"	16'-1"	15'-0"	14'-4"	13'-7"
	11-7/8"	17'-1"	15'-11"	15'-3"	14'-6"	17'-9"	16'-6"	15'-9"	15'-0"	17'-6"	16'-4"	15'-8"	14'-10"	18'-3"	16'-11"	16'-2"	15'-5"
	14"	18'-11"	17'-5"	16'-8"	15'-10"	19'-10"	18'-2"	17'-3"	16'-5"	19'-6"	17'-11"	17'-1"	16'-3"	20'-6"	18'-9"	17'-9"	16'-10"
PWI 32S, LPI 32Plus	9-1/2"	15'-9"	14'-8"	14'-0"	13'-4"	16'-3"	15'-2"	14'-6"	13'-9"	16'-1"	15'-0"	14'-4"	13'-7"	16'-8"	15'-6"	14'-10"	14'-1"
	11-7/8"	17'-9"	16'-6"	15'-9"	15'-0"	18'-6"	17'-1"	16'-4"	15'-6"	18'-2"	16'-11"	16'-2"	15'-4"	19'-1"	17'-6"	16'-9"	15'-11"
	14"	19'-8"	18'-0"	17'-2"	16'-4"	20'-8"	18'-10"	17'-10"	16'-11"	20'-3"	18'-6"	17'-7"	16'-9"	21'-3"	19'-6"	18'-5"	17'-4"
PWI 36L, LPI 36	9-1/2"	15'-9"	14'-8"	14'-0"	13'-4"	16'-3"	15'-2"	14'-6"	13'-9"	16'-1"	15'-0"	14'-4"	13'-7"	16'-8"	15'-6"	14'-10"	14'-1"
	11-7/8"	17'-9"	16'-6"	15'-9"	15'-0"	18'-6"	17'-1"	16'-4"	15'-6"	18'-2"	16'-11"	16'-2"	15'-4"	19'-1"	17'-6"	16'-9"	15'-11"
	14"	19'-8"	18'-0"	17'-2"	16'-4"	20'-8"	18'-10"	17'-10"	16'-11"	20'-3"	18'-6"	17'-7"	16'-9"	21'-3"	19'-6"	18'-5"	17'-4"
PWI 42S, LPI 42Plus	9-1/2"	17'-1"	15'-11"	15'-3"	14'-5"	17'-8"	16'-6"	15'-9"	14'-11"	17'-5"	16'-3"	15'-6"	14'-9"	18'-1"	16'-11"	16'-1"	15'-3"
	11-7/8"	19'-8"	17'-11"	17'-2"	16'-3"	20'-7"	18'-10"	17'-9"	16'-11"	20'-1"	18'-5"	17'-6"	16'-7"	21'-1"	19'-4"	18'-3"	17'-3"
	14"	21'-11"	20'-0"	18'-11"	17'-9"	23'-0"	21'-0"	19'-10"	18'-7"	22'-5"	20'-6"	19'-5"	18'-2"	23'-7"	21'-7"	20'-5"	19'-1"
PWI 52S, LPI 52Plus	9-1/2"	17'-1"	15'-11"	15'-3"	14'-5"	17'-8"	16'-6"	15'-9"	14'-11"	17'-5"	16'-3"	15'-6"	14'-9"	18'-1"	16'-11"	16'-1"	15'-3"
	11-7/8"	19'-8"	17'-11"	17'-2"	16'-3"	20'-7"	18'-10"	17'-9"	16'-11"	20'-1"	18'-5"	17'-6"	16'-7"	21'-1"	19'-4"	18'-3"	17'-3"
	14"	21'-11"	20'-0"	18'-11"	17'-9"	23'-0"	21'-0"	19'-10"	18'-7"	22'-5"	20'-6"	19'-5"	18'-2"	23'-7"	21'-7"	20'-5"	19'-1"
PWI 56L, LPI 56	9-1/2"	17'-1"	15'-11"	15'-3"	14'-5"	17'-8"	16'-6"	15'-9"	14'-11"	17'-5"	16'-3"	15'-6"	14'-9"	18'-1"	16'-11"	16'-1"	15'-3"
	11-7/8"	19'-8"	17'-11"	17'-2"	16'-3"	20'-7"	18'-10"	17'-9"	16'-11"	20'-1"	18'-5"	17'-6"	16'-7"	21'-1"	19'-4"	18'-3"	17'-3"
	14"	21'-11"	20'-0"	18'-11"	17'-9"	23'-0"	21'-0"	19'-10"	18'-7"	22'-5"	20'-6"	19'-5"	18'-2"	23'-7"	21'-7"	20'-5"	19'-1"

3/4 OSB SHEATHING GLUED & NAILED

Series	Depth	No Direct Attached Ceiling								Direct Attached 1/2" Gypsum Ceiling							
		Maximum Simple Spans				Maximum Continuous Spans				Maximum Simple Spans				Maximum Continuous Spans			
		12" oc	16" oc	19.2" oc	24" oc	12" oc	16" oc	19.2" oc	24" oc	12" oc	16" oc	19.2" oc	24" oc	12" oc	16" oc	19.2" oc	24" oc
PWI 18S, LPI 18	9-1/2"	15'-10"	15'-0"	14'-4"	13'-2"	16'-5"	15'-6"	14'-11"	13'-7"	16'-4"	15'-3"	14'-4"	13'-2"	16'-11"	16'-0"	15'-2"	13'-7"
	11-7/8"	17'-10"	16'-10"	16'-3"	14'-10"	18'-7"	17'-5"	16'-7"	14'-9"	18'-5"	17'-4"	16'-8"	14'-10"	19'-4"	18'-0"	16'-7"	14'-9"
	14"	19'-11"	18'-10"	17'-6"	15'-10"	20'-9"	19'-3"	18'-3"	16'-11"	20'-6"	19'-5"	18'-2"	16'-10"	21'-0"	20'-0"	19'-0"	17'-2"
PWI 20S, LPI 20Plus	9-1/2"	16'-6"	15'-7"	15'-0"	14'-5"	17'-1"	16'-1"	15'-6"	14'-10"	16'-11"	16'-0"	15'-5"	14'-5"	17'-6"	16'-6"	15'-11"	15'-2"
	11-7/8"	18'-8"	17'-5"	16'-10"	16'-1"	19'-6"	18'-1"	17'-5"	16'-8"	19'-3"	17'-11"	17'-3"	16'-7"	20'-3"	18'-10"	17'-11"	17'-2"
	14"	20'-9"	19'-3"	18'-4"	17'-6"	21'-9"	20'-2"	19'-3"	18'-3"	21'-6"	20'-0"	19'-1"	18'-1"	22'-7"	21'-0"	20'-0"	19'-0"
PWI 32S, LPI 32Plus	9-1/2"	17'-0"	16'-0"	15'-5"	14'-9"	17'-7"	16'-7"	15'-11"	15'-3"	17'-5"	16'-5"	15'-10"	15'-2"	18'-1"	17'-0"	16'-4"	15'-8"
	11-7/8"	19'-4"	17'-11"	17'-3"	16'-6"	20'-3"	18'-9"	17'-10"	17'-1"	19'-11"	18'-6"	17'-8"	17'-0"	20'-10"	19'-5"	18'-6"	17'-7"
	14"	21'-5"	19'-10"	18'-11"	17'-11"	22'-6"	20'-10"	19'-10"	18'-9"	22'-1"	20'-6"	19'-7"	18'-7"	23'-2"	21'-7"	20'-7"	19'-5"
PWI 36L, LPI 36	9-1/2"	17'-0"	16'-0"	15'-5"	14'-9"	17'-7"	16'-7"	15'-11"	15'-3"	17'-5"	16'-5"	15'-10"	15'-2"	18'-1"	17'-0"	16'-4"	15'-8"
	11-7/8"	19'-4"	17'-11"	17'-3"	16'-6"	20'-3"	18'-9"	17'-10"	17'-1"	19'-11"	18'-6"	17'-8"	17'-0"	20'-10"	19'-5"	18'-6"	17'-7"
	14"	21'-5"	19'-10"	18'-11"	17'-11"	22'-6"	20'-10"	19'-10"	18'-9"	22'-1"	20'-6"	19'-7"	18'-7"	23'-2"	21'-7"	20'-7"	19'-5"
PWI 42S, LPI 42Plus	9-1/2"	18'-2"	17'-1"	16'-5"	15'-9"	19'-1"	17'-8"	17'-0"	16'-3"	18'-7"	17'-5"	16'-9"	16'-0"	19'-6"	18'-1"	17'-4"	16'-7"
	11-7/8"	21'-0"	19'-5"	18'-6"	17'-7"	22'-1"	20'-5"	19'-5"	18'-4"	21'-7"	20'-0"	19'-0"	18'-0"	22'-7"	20'-11"	19'-11"	18'-11"
	14"	23'-5"	21'-7"	20'-7"	19'-5"	24'-6"	22'-8"	21'-7"	20'-5"	24'-0"	22'-2"	21'-2"	20'-0"	25'-2"	23'-4"	22'-2"	21'-0"
PWI 52S, LPI 52Plus	9-1/2"	18'-2"	17'-1"	16'-5"	15'-9"	19'-1"	17'-8"	17'-0"	16'-3"	18'-7"	17'-5"	16'-9"	16'-0"	19'-6"	18'-1"	17'-4"	16'-7"
	11-7/8"	21'-0"	19'-5"	18'-6"	17'-7"	22'-1"	20'-5"	19'-5"	18'-4"	21'-7"	20'-0"	19'-0"	18'-0"	22'-7"	20'-11"	19'-11"	18'-11"
	14"	23'-5"	21'-7"	20'-7"	19'-5"	24'-6"	22'-8"	21'-7"	20'-5"	24'-0"	22'-2"	21'-2"	20'-0"	25'-2"	23'-4"	22'-2"	21'-0"
PWI 56L, LPI 56	9-1/2"	17'-0"	16'-0"	15'-5"	14'-9"	17'-7"	16'-7"	15'-11"	15'-3"	17'-5"	16'-5"	15'-10"	15'-2"	18'-1"	17'-0"	16'-4"	15'-8"
	11-7/8"	19'-4"	17'-11"	17'-3"	16'-6"	20'-3"	18'-9"	17'-10"	17'-1"	19'-11"	18'-6"	17'-8"	17'-0"	20'-10"	19'-5"	18'-6"	17'-7"
	14"	21'-5"	19'-10"	18'-11"	17'-11"	22'-6"	20'-10"	19'-10"	18'-9"	22'-1"	20'-6"	19'-7"	18'-7"	23'-2"	21'-7"	20'-7"	19'-5"

Design Assumptions:

1. The spans listed are the clear distance between supports. Continuous spans are based on the longest span. The shortest span shall not be less than 50% of the longest span.
2. The spans are based on uniform floor loads only, for standard load duration.
3. These tables reflect the additional stiffness for vibration provided by a 3/4 OSB rated sheathing, or equal, attached as indicated (Nailed Only or Glued & Nailed) to the top flange.
4. Live load deflection is limited to L/360 "bare joist."
5. Total load deflection is limited to L/240.
6. The spans are based on an end bearing length of at least 1-3/4" and an interior bearing length of at least 3-1/2," and are limited to the bearing resistance of an SPF wall plate.

Additional Notes:

1. These spans have been designed to meet the Limit States Design and vibration requirements of the National Building Code of Canada.
2. Web stiffeners are not required for any of the spans in these tables.
3. Web fillers are required for I-Joists seated in hangers that do not laterally support the top flange.
4. For conditions not shown, use the Uniform Floor Load (PLF) tables, use the Exacte by PWT software or contact your PWT™ distributor for assistance.

Uniform Floor Load (PLF) Tables: 9½" & 11⅞"

Span	9-1/2" PWI 18S, LPI 18			9-1/2" PWI 20S, LPI 20Plus			9-1/2" PWI 32S, LPI 32Plus			9-1/2" PWI 42S, LPI 42Plus		
	Deflection		Factored Total Load	Deflection		Factored Total Load	Deflection		Factored Total Load	Deflection		Factored Total Load
	Live L/480	Total L/240		Live L/480	Total L/240		Live L/480	Total L/240		Live L/480	Total L/240	
8'	231		303	284		337	323		337		424	
9'	171		270	212		301	243		301	331	377	
10'	129		244	161		271	186		271	256	339	
11'	100	200	222	125		247	145		247	202	308	
12'	78	157	201	99	199	227	116		227	161	282	
13'	63	126	172	80	160	209	93	187	209	131	260	
14'	51	102	149	65	130	185	76	153	195	107	242	
15'	42	84	130	53	107	161	63	126	182	89	225	
16'	35	70	114	45	90	142	52	105	169	75	211	
17'	29	59	101	37	75	126	44	89	150	63	199	
18'	25	50	90	32	64	112	38	76	134	54	188	
19'	21	43	81	27	55	101	32	65	120	46	178	
20'	18	37	73	23	47	91	28	56	109	40	169	
21'	16	32	66	20	41	83	24	49	99	35	159	
22'	-	-	-	18	36	75	21	42	90	30	145	
23'	-	-	-	15	31	69	18	37	82	27	132	
24'	-	-	-	-	-	-	16	33	76	23	122	
25'	-	-	-	-	-	-	-	-	-	21	112	
26'	-	-	-	-	-	-	-	-	-	19	104	
27'	-	-	-	-	-	-	-	-	-	17	96	
28'	-	-	-	-	-	-	-	-	-	15	89	

Table Usage:

1. Select the span required.
2. Compare the factored design total load to the Factored Total Load column.
3. Compare the specified design total load to the Total L/240 column.
4. Compare the specified design live load to the Live L/480 column. For a live load deflection limit of L/360, refer to Additional Note 4 below.
5. Select a product that satisfies all three conditions.

Example:

Select an I-Joist for a 17'-6" clear span supporting specified loads of 40 psf Live Load and 20 psf Dead Load, spaced 16' oc, at an L/480 deflection limit.

$$\text{Factored Total Load} = (1.50 \times 40 + 1.25 \times 20) \times (16 / 12) = 114 \text{ plf}$$

$$\text{Unfactored Total Load} = (40 + 20) \times (16 / 12) = 80 \text{ plf}$$

$$\text{Unfactored Live Load} = 40 \times (16 / 12) = 54 \text{ plf}$$

2. Select the row corresponding to an 18' span.
3. Select the first joist to exceed all three resistance criteria:

The 9-1/2" PWI 42S supports 185 plf Factored Total Load, 108 plf Total L/240 Deflection and 54 plf Live L/480 Deflection resistance.

Span	11-7/8" PWI 18S, LPI 18			11-7/8" PWI 20S, LPI 20Plus			11-7/8" PWI 32S, LPI 32Plus			11-7/8" PWI 36L, LPI 36			11-7/8" PWI 42S, LPI 42Plus			11-7/8" PWI 52S, LPI 52Plus			11-7/8" PWI 56L, LPI 56		
	Deflection		Factored Total Load	Deflection		Factored Total Load	Deflection		Factored Total Load	Deflection		Factored Total Load	Deflection		Factored Total Load	Deflection		Factored Total Load	Deflection		Factored Total Load
	Live L/480	Total L/240		Live L/480	Total L/240		Live L/480	Total L/240		Live L/480	Total L/240		Live L/480	Total L/240		Live L/480	Total L/240		Live L/480	Total L/240	
8'			322			358			358			384			465			526			449
9'	278		287			319			319			342			414			469			401
10'	212		259	258		288			288			308			374			423			362
11'	166		235	203		262	231		262	281		319			340	361		385			330
12'	131		216	162		241	185		241	209		258	258		312	290		353			303
13'	106		200	131		222	150		222	170		238	210		289	236		327	249		280
14'	86	173	176	107		207	124		207	140		221	174		268	195		304	207		260
15'	71	143	153	89	178	193	103		193	116		207	145		251	162		284	173		243
16'	59	119	135	74	149	181	86	173	181	98		194	122		235	136		266	146		228
17'	50	101	120	63	126	168	73	146	171	83	166	183	104	208	222	116	232	251	124		215
18'	42	85	107	54	108	150	62	125	161	71	142	173	89	178	209	99	198	237	107		203
19'	36	73	96	46	92	135	53	107	153	61	122	164	76	153	198	85	170	224	92	184	193
20'	31	63	87	40	80	122	46	93	141	53	106	155	66	133	189	74	148	213	80	160	183
21'	27	55	79	34	69	111	40	81	128	46	92	148	58	116	180	64	129	203	70	140	175
22'	24	48	72	30	61	101	35	71	116	40	81	141	51	102	172	56	113	194	61	123	167
23'	21	42	66	26	53	92	31	62	107	35	71	135	45	90	164	49	99	186	54	109	160
24'	18	37	60	23	47	85	27	55	98	31	63	130	40	80	157	44	88	178	48	96	153
25'	16	33	56	21	42	78	24	49	90	28	56	125	35	71	145	39	78	171	43	86	147
26'	-	-	-	18	37	72	22	44	83	25	50	120	31	63	134	35	70	164	38	77	141
27'	-	-	-	16	33	67	19	39	77	22	45	115	28	57	125	31	63	152	34	69	136
28'	-	-	-	15	30	62	17	35	72	20	40	107	25	51	116	28	56	141	31	62	131

Design Assumptions:

1. Span is the clear distance between supports and is valid for simple or continuous span applications. Continuous spans are based on the longest span. The shortest span shall not be less than 50% of the longest span.
2. The values in the tables are for uniform loads only.
3. Factored Total Load resistance is for standard (100%) load duration.
4. These tables do not reflect any additional stiffness provided by the floor sheathing.
5. Live L/480 Deflection resistance is limited to L/480. Vibration has not been considered.
6. Total L/240 Deflection resistance is limited to L/240. Long term deflection (creep) has not been considered.
7. These tables assume full lateral support of the compression flange. Full support is considered to be a maximum unbraced length of 24."
8. These tables are based on an end bearing length of at least 1-3/4" and an interior bearing length of at least 3-1/2," and are limited to the bearing capacity for an SPF wall plate.

Additional Notes:

1. These tables have been designed to meet the Limit States Design requirements of the National Building Code of Canada.
2. The tabulated resistances represent the capacity of the member in pounds per lineal foot (plf) of length.
3. The designer shall check the Factored Total Load, the Total L/240 Deflection and the Live L/480 Deflection resistance columns.
4. To design for an L/360 live load deflection, multiply the Live L/480 Deflection values by 1.33 or refer to the Uniform Roof Load (PLF) Tables on page 11.
5. Where the Deflection resistance is blank, the Factored Total Load resistance governs the design.
6. To design a double I-Joist, the values in these tables can be doubled, or the design loads on the I-Joist may be halved to verify the capacity of each ply. The capacity is additive.
7. Web stiffeners are not required for these spans and loads.
8. Web fillers are required for I-Joists seated in hangers that do not laterally support the top flange or for hangers that require nailing into the web.
9. Do not use a product where designated "-" without further analysis by a design professional.

PSF TO PLF CONVERSION

OC Spacing	Load									
	20 psf	25 psf	30 psf	35 psf	40 psf	45 psf	50 psf	55 psf	60 psf	65 psf
12"	20	25	30	35	40	45	50	55	60	65
16"	27	34	40	47	54	60	67	74	80	87
19.2"	32	40	48	56	64	72	80	88	96	104
24"	40	50	60	70	80	90	100	110	120	130

To Convert from Specified to Factored Total PLF:

$$\text{Factored Total plf} = 1.50 \times \text{Specified Live plf} + 1.25 \times \text{Specified Dead plf}$$

Uniform Floor Load (PLF) Tables: 14" & 16"

Table Usage:

1. Select the span required.
2. Compare the factored design total load to the Factored Total Load column.
3. Compare the specified design total load to the Total L/240 column.
4. Compare the specified design live load to the Live L/480 column. For a live load deflection limit of L/360, refer to Additional Note 4 below.
5. Select a product that satisfies all three conditions.

Example: Select an I-Joist for a 20'-6" clear span supporting specified loads of 40 psf Live Load and 20 psf Dead Load, spaced 16" oc, at an L/480 deflection limit.

1. Factored Total Load = $(1.50 \times 40 + 1.25 \times 20) \times (16 / 12) = 114$ plf
 Unfactored Total Load = $(40 + 20) \times (16 / 12) = 80$ plf
 Unfactored Live Load = $40 \times (16 / 12) = 54$ plf
2. Select the row corresponding to an 21' span.
3. Select the first joist to exceed all three resistance criteria:

The 14" PWI 32S supports 145 plf Factored Total Load, 116 plf Total L/240 Deflection and 58 plf Live L/480 Deflection resistance.

Span	14" PWI 20S, LPI 20Plus			14" PWI 32S, LPI 32Plus			14" PWI 36L, LPI 36			14" PWI 42S, LPI 42Plus			14" PWI 52S, LPI 52Plus			14" PWI 56L, LPI 56		
	Deflection		Factored Total Load	Deflection		Factored Total Load	Deflection		Factored Total Load	Deflection		Factored Total Load	Deflection		Factored Total Load	Deflection		Factored Total Load
	Live L/480	Total L/240		Live L/480	Total L/240		Live L/480	Total L/240		Live L/480	Total L/240		Live L/480	Total L/240		Live L/480	Total L/240	
14'	154		218	174		218	195		221	244		279	273		305			261
15'	129		203	145		203	163		207	204		260	228		285	240		244
16'	108		191	122		191	138		194	173		244	193		267	203		229
17'	91		180	104		180	117		183	147		230	164		251	174		215
18'	78	157	170	89		170	100		173	126		217	140		238	150		204
19'	67	135	158	77	154	161	86		164	109		206	121		225	129		193
20'	58	117	143	66	133	153	75	150	155	95	190	196	105	211	214	113		184
21'	51	102	130	58	116	146	65	131	148	83	167	186	92	184	204	99		175
22'	44	89	118	51	102	139	57	115	141	73	146	178	81	162	195	87		167
23'	39	79	108	45	90	128	51	102	135	64	129	170	71	143	186	77	154	160
24'	35	70	99	40	80	118	45	90	130	57	115	163	63	126	179	68	137	153
25'	31	62	92	35	71	109	40	80	125	51	102	157	56	113	172	61	122	147
26'	27	55	85	31	63	101	36	72	120	46	92	151	50	101	165	54	109	142
27'	24	49	79	28	57	93	32	64	115	41	82	145	45	90	159	49	98	136
28'	22	45	73	25	51	87	29	58	111	37	74	140	40	81	153	44	89	131
29'	20	40	68	23	46	81	26	52	107	33	67	130	37	74	148	40	80	127
30'	18	36	64	21	42	76	23	47	104	30	61	122	33	67	143	36	73	123
31'	16	33	60	19	38	71	21	43	101	27	55	114	30	61	138	33	66	119
32'	15	30	56	17	35	66	19	39	97	25	50	107	27	55	130	30	60	115
33'	-	-	-	16	32	62	18	36	93	23	46	101	25	51	123	27	55	112
34'	-	-	-	-	-	-	16	33	88	21	42	95	23	46	115	25	51	108

Span	16" PWI 20S, LPI 20Plus			16" PWI 32S, LPI 32Plus			16" PWI 36L, LPI 36			16" PWI 42S, LPI 42Plus			16" PWI 52S, LPI 52Plus			16" PWI 56L, LPI 56		
	Deflection		Factored Total Load	Deflection		Factored Total Load	Deflection		Factored Total Load	Deflection		Factored Total Load	Deflection		Factored Total Load	Deflection		Factored Total Load
	Live L/480	Total L/240		Live L/480	Total L/240		Live L/480	Total L/240		Live L/480	Total L/240		Live L/480	Total L/240		Live L/480	Total L/240	
14'	205		220			220			221			288			306			261
15'	171		205	191		205			207	268		269			286			244
16'	145		193	161		193	180		194	227		252	253		268			229
17'	123		181	137		181	153		183	195		238	216		253			216
18'	105		171	118		171	132		173	167		224	185		239	195		204
19'	91		163	102		163	114		164	145		213	160		226	169		193
20'	79		154	88		154	99		155	126		202	139		215	148		184
21'	69	138	147	77		147	86		148	111		193	122		205	130		175
22'	60	121	136	68	136	141	76		141	98		184	107		196	114		167
23'	53	107	124	60	120	135	67		135	86	173	176	95		187	101		160
24'	47	95	114	53	107	129	60	120	130	77	154	169	84	169	179	90		153
25'	42	84	105	47	95	124	53	107	125	68	137	162	75	151	172	80		147
26'	37	75	97	42	85	117	47	95	120	61	123	156	67	135	166	72		142
27'	33	67	90	38	76	108	43	86	115	55	111	150	60	121	160	65	130	137
28'	30	61	84	34	69	101	38	77	111	50	100	145	54	109	154	59	118	132
29'	27	55	78	31	62	94	35	70	107	45	90	140	49	99	149	53	107	127
30'	25	50	73	28	56	88	31	63	104	41	82	135	45	90	144	48	97	123
31'	22	45	68	25	51	82	29	58	101	37	75	131	40	81	139	44	88	119
32'	20	41	64	23	47	77	26	52	97	34	68	124	37	74	135	40	80	115
33'	19	38	60	21	43	73	24	48	94	31	62	117	34	68	131	37	74	112
34'	17	34	57	19	39	68	22	44	92	28	57	110	31	62	127	34	68	109

Design Assumptions:

1. Span is the clear distance between supports and is valid for simple or continuous span applications. Continuous spans are based on the longest span. The shortest span shall not be less than 50% of the longest span.
2. The values in the tables are for uniform loads only.
3. Factored Total Load resistance is for standard (100%) load duration.
4. These tables do not reflect any additional stiffness provided by the floor sheathing.
5. Live L/480 Deflection resistance is limited to L/480. Vibration has not been considered.
6. Total L/240 Deflection resistance is limited to L/240. Long term deflection (creep) has not been considered.
7. These tables assume full lateral support of the compression flange. Full support is considered to be a maximum unbraced length of 24'.
8. These tables are based on an end bearing length of at least 1-3/4" and an interior bearing length of at least 3-1/2," and are limited to the bearing capacity for an SPF wall plate.

Additional Notes:

1. These tables have been designed to meet the Limit States Design requirements of the National Building Code of Canada.
2. The tabulated resistances represent the capacity of the member in pounds per lineal foot (plf) of length.
3. The designer shall check the Factored Total Load, the Total L/240 Deflection and the Live L/480 Deflection resistance columns.
4. To design for an L/360 live load deflection, multiply the Live L/480 Deflection values by 1.33 or refer to the Uniform Roof Load (PLF) Tables on page 12.
5. Where the Deflection resistance is blank, the Factored Total Load resistance governs the design.
6. To design a double I-Joist, the values in these tables can be doubled, or the design loads on the I-Joist may be halved to verify the capacity of each ply. The capacity is additive.
7. Web stiffeners are not required for these spans and loads.
8. Web fillers are required for I-Joists seated in hangers that do not laterally support the top flange or for hangers that require nailing into the web.
9. Do not use a product where designated "-" without further analysis by a design professional.

PSF TO PLF CONVERSION

OC Spacing	Load									
	20 psf	25 psf	30 psf	35 psf	40 psf	45 psf	50 psf	55 psf	60 psf	65 psf
12"	20	25	30	35	40	45	50	55	60	65
16"	27	34	40	47	54	60	67	74	80	87
19.2"	32	40	48	56	64	72	80	88	96	104
24"	40	50	60	70	80	90	100	110	120	130

To Convert from Specified to Factored Total PLF:

Factored Total plf = 1.50 x Specified Live plf + 1.25 x Specified Dead plf

Uniform Roof Load (PLF) Tables: 9½" & 11⅞"

Span	9-1/2" PWI 18S, LPI 18			9-1/2" PWI 20S, LPI 20Plus			9-1/2" PWI 32S, LPI 32Plus			9-1/2" PWI 42S, LPI 42Plus		
	Deflection		Factored Total Load	Deflection		Factored Total Load	Deflection		Factored Total Load	Deflection		Factored Total Load
	Live L/360	Total L/180		Live L/360	Total L/180		Live L/360	Total L/180		Live L/360	Total L/180	
8'			303			337			337			424
9'	228		270	282		301			301			377
10'	172		244	215		271	248		271			339
11'	133		222	167		247	194		247	269		308
12'	105		201	132		227	154		227	215		282
13'	84	168	172	106		209	124		209	175		260
14'	68	137	149	87	174	185	102		195	143		242
15'	56	112	130	71	143	161	84	168	182	119		225
16'	46	93	114	60	120	142	70	141	169	100	200	211
17'	39	78	101	50	101	126	59	119	150	84	169	199
18'	33	67	90	43	86	112	50	101	134	72	144	188
19'	28	57	81	36	73	101	43	87	120	62	124	178
20'	24	49	73	31	63	91	37	75	109	53	107	169
21'	21	42	66	27	55	83	32	65	99	46	93	159
22'	18	37	60	24	48	75	28	57	90	41	82	145
23'	16	32	55	21	42	69	25	50	82	36	72	132
24'	-	-	-	18	37	63	22	44	76	31	63	122
25'	-	-	-	16	33	58	19	39	70	28	56	112
26'	-	-	-	-	-	-	17	35	64	25	50	104
27'	-	-	-	-	-	-	15	31	60	22	45	96
28'	-	-	-	-	-	-	-	-	-	20	40	89

Table Usage:

- Select the span required. For roofs with a slope of 2:12 or greater, the horizontal span shall be multiplied by the appropriate roof pitch adjustment factor from the table at the bottom of this page.
- Compare the factored design total load to the Factored Total Load column.
- Compare the specified design total load to the Total L/180 column.
- Compare the specified design live load to the Live L/360 column. For a live load deflection limit of L/480 or L/240, refer to Additional Note 5 below.
- Select a product that satisfies all three conditions.

Example: Select an I-Joist for a 12'-8" horizontal clear span supporting 45 psf Snow (Live) Load and 15 psf Dead Load, spaced 24" oc, with a roof slope of 6:12, at an L/360 deflection limit.

- Factored Total Load = $(1.50 \times 45 + 1.25 \times 15) \times (24 / 12) = 173$ plf
Unfactored Total Load = $(45 + 15) \times (24 / 12) = 120$ plf
Unfactored Live Load = $45 \times (24 / 12) = 90$ plf
- Sloped Span = $(12 + 8/12) \times 1.118 = 14.16'$
- Select the row corresponding to a 15' span.
- Select the first joist to exceed all three resistance criteria:

The 9-1/2" PWI 42S supports 222 plf Factored Total Load and 118 plf Live L/360 Deflection. Total L/180 Deflection does not control.

Span	11-7/8" PWI 18S, LPI 18			11-7/8" PWI 20S, LPI 20Plus			11-7/8" PWI 32S, LPI 32Plus			11-7/8" PWI 36L, LPI 36			11-7/8" PWI 42S, LPI 42Plus			11-7/8" PWI 52S, LPI 52Plus			11-7/8" PWI 56L, LPI 56		
	Deflection		Factored Total Load	Deflection		Factored Total Load	Deflection		Factored Total Load	Deflection		Factored Total Load	Deflection		Factored Total Load	Deflection		Factored Total Load	Deflection		Factored Total Load
	Live L/360	Total L/180		Live L/360	Total L/180		Live L/360	Total L/180		Live L/360	Total L/180		Live L/360	Total L/180		Live L/360	Total L/180		Live L/360	Total L/180	
8'			322			358			358			384			465			526			449
9'			287			319			319			342			414			469			401
10'			259			288			288			308			374			423			362
11'	221		235			262			262			281			340			385			330
12'	175		216	216		241			241			258			312			353			303
13'	141		200	175		222	201		222	227		238	281		289	315		327			280
14'	115		176	143		207	165		207	187		221	232		268	260		304			260
15'	95		153	119		193	137		193	155		207	194		251	216		284	231		243
16'	79		135	99		181	115		181	131		194	163		235	182		266	195		228
17'	67		120	84		168	97		171	111		183	138		222	154		251	166		215
18'	57		107	72	144		150	83		161	94		173	118		209	132		237	142	203
19'	49		96	61	123	135	71	143	153	81	163	164	102		198	113		224	123		193
20'	42	84	87	53	107	122	62	124	141	70	141	155	89	178	189	98	197	213	107		183
21'	36	73	79	46	93	111	54	108	128	61	123	148	77	155	180	86	172	203	93		175
22'	32	64	72	40	81	101	47	95	116	54	108	141	68	136	172	75	151	194	82	164	167
23'	28	56	66	35	71	92	41	83	107	47	95	135	60	120	164	66	133	186	72	145	160
24'	25	50	60	31	63	85	37	74	98	42	84	130	53	106	157	59	118	178	64	128	153
25'	22	44	56	28	56	78	33	66	90	37	75	125	47	95	145	52	105	171	57	114	147
26'	19	39	51	25	50	72	29	59	83	33	67	120	42	85	134	46	93	164	51	102	141
27'	17	35	48	22	45	67	26	52	77	30	60	115	38	76	125	42	84	152	46	92	136
28'	16	32	44	20	40	62	23	47	72	27	54	107	34	68	116	37	75	141	41	83	131

Design Assumptions:

- Span is the clear distance between supports and is valid for simple or continuous span applications. Continuous spans are based on the longest span. The shortest span shall not be less than 50% of the longest span.
- The values in the tables are for uniform loads only.
- Factored Total Load resistance is for standard (100%) load duration.
- These tables do not reflect any additional stiffness provided by the sheathing.
- Live L/360 Deflection resistance is limited to L/360. Vibration has not been considered.
- Total L/180 Deflection resistance is limited to L/180. Long term deflection (creep) has not been considered.
- These tables assume full lateral support of the compression flange. Full support is considered to be a maximum unbraced length of 24."
- These tables are based on an end bearing length of at least 1-3/4" and an interior bearing length of at least 3-1/2," and are limited to the bearing capacity for an SPF wall plate.

Additional Notes:

- These tables have been designed to meet the Limit States Design requirements of the National Building Code of Canada.
- The tabulated resistances represent the capacity of the member in pounds per lineal foot (plf) of length.
- For roofs with a slope of 2:12 or greater, the horizontal span shall be multiplied by the appropriate pitch adjustment factor from the table at the bottom of this page. Roof joists shall have a minimum pitch of 1/4" per foot (1/4:12) for positive drainage.
- The designer shall check the Factored Total Load, the Total L/180 Deflection and the Live L/360 Deflection resistance columns.
- To design for an L/240 live load deflection, multiply the Live L/360 Deflection values by 1.5. To design for a L/480 live load deflection, multiply the Live L/360 Deflection values by 0.75 or refer to the Uniform Floor Load (PLF) Tables on page 9.
- Where the Deflection resistance is blank, the Factored Total Load resistance governs the design.
- To design a double I-Joist, the values in these tables can be doubled, or the design loads on the I-Joist may be halved to verify the capacity of each ply. The capacity is additive.
- Web stiffeners are not required for these spans and loads.
- Web fillers are required for I-Joists seated in hangers that do not laterally support the top flange or for hangers that require nailing into the web.
- Do not use a product where designated "-" without further analysis by a design professional.

ROOF PITCH ADJUSTMENT FACTORS

Roof Pitch	2:12	3:12	4:12	5:12	6:12	7:12	8:12	9:12	10:12	11:12	12:12
Factor	1.014	1.031	1.054	1.083	1.118	1.158	1.202	1.250	1.302	1.357	1.414

Uniform Roof Load (PLF) Tables: 14" & 16"

Table Usage:

- Select the span required. For roofs with a pitch of 2:12 or greater, the horizontal span shall be multiplied by the appropriate roof pitch adjustment factor from the table at the bottom of this page.
- Compare the factored design total load to the Factored Total Load column.
- Compare the specified design total load to the Total L/180 column.
- Compare the specified design live load to the Live L/360 column. For a live load deflection limit of L/480 or L/240, refer to Additional Note 5 below.
- Select a product that satisfies all three conditions.

Example: Select an I-Joist for a 17'-8" horizontal clear span supporting 45 psf Snow (Live) Load and 15 psf Dead Load, spaced 24" oc, with a roof pitch of 6:12, at an L/360 deflection limit.

- Factored Total Load = $(1.50 \times 45 + 1.25 \times 15) \times (24 / 12) = 173$ plf
 Unfactored Total Load = $(45 + 15) \times (24 / 12) = 120$ plf
 Unfactored Live Load = $45 \times (24 / 12) = 90$ plf
- Sloped Span = $(17 + 8/12) \times 1.118 = 19.75'$
- Select the row corresponding to a 20' span.
- Select the first joist to exceed all three resistance criteria:

The 14" PWI 42S supports 195 plf Factored Total Load and 126 plf Live L/360 Deflection. Total L/180 Deflection does not control.

Span	14" PWI 20S, LPI 20Plus			14" PWI 32S, LPI 32Plus			14" PWI 36L, LPI 36			14" PWI 42S, LPI 42Plus			14" PWI 52S, LPI 52Plus			14" PWI 56L, LPI 56		
	Deflection		Factored Total Load	Deflection		Factored Total Load	Deflection		Factored Total Load	Deflection		Factored Total Load	Deflection		Factored Total Load	Deflection		Factored Total Load
	Live L/360	Total L/180		Live L/360	Total L/180		Live L/360	Total L/180		Live L/360	Total L/180		Live L/360	Total L/180		Live L/360	Total L/180	
14'	206		218			218			221			279			305			261
15'	172		203	194		203			207			260			285			244
16'	144		191	163		191	184		194	231		244	257		267			229
17'	122		180	139		180	156		183	197		230	218		251			215
18'	104		170	119		170	134		173	169		217	187	200	238			204
19'	90		158	102		161	115		164	146		206	162	173	225			193
20'	78		143	89		153	100		155	127		196	140	150	214			184
21'	68		130	77		146	87		148	111		186	123	132	204			175
22'	59		118	68	136	139	77		141	97		178	108	116	195			167
23'	52	105	108	60	120	128	68		135	86		170	95	103	186			160
24'	46	93	99	53	107	118	60	120	130	76	153	163	84	169	179	91		153
25'	41	83	92	47	95	109	53	107	125	68	137	157	75	150	172	81		147
26'	37	74	85	42	85	101	48	96	120	61	122	151	67	134	165	73		142
27'	33	66	79	38	76	93	43	86	115	55	110	145	60	121	159	65	131	136
28'	30	60	73	34	68	87	38	77	111	49	99	140	54	109	153	59	118	131
29'	27	54	68	31	62	81	35	70	107	44	89	130	49	98	148	53	107	127
30'	24	49	64	28	56	76	31	63	104	40	81	122	44	89	143	48	97	123
31'	22	44	60	25	51	71	29	58	101	37	74	114	40	81	138	44	88	119
32'	20	40	56	23	46	66	26	53	97	33	67	107	37	74	130	40	81	115
33'	18	37	53	21	42	62	24	48	93	31	62	101	34	68	123	37	74	112
34'	17	34	50	19	39	59	22	44	88	28	56	95	31	62	115	34	68	108

Span	16" PWI 20S, LPI 20Plus			16" PWI 32S, LPI 32Plus			16" PWI 36L, LPI 36			16" PWI 42S, LPI 42Plus			16" PWI 52S, LPI 52Plus			16" PWI 56L, LPI 56		
	Deflection		Factored Total Load	Deflection		Factored Total Load	Deflection		Factored Total Load	Deflection		Factored Total Load	Deflection		Factored Total Load	Deflection		Factored Total Load
	Live L/360	Total L/180		Live L/360	Total L/180		Live L/360	Total L/180		Live L/360	Total L/180		Live L/360	Total L/180		Live L/360	Total L/180	
14'			220			220			221			288			306			261
15'			205			205			207			269			286			244
16'			193			193			194			252			268			229
17'	164		181			181			183			238			253			216
18'	140		171	157		171			173	223		224			239			204
19'	121		163	136		163	152		164	194		213	214		226			193
20'	105		154	118		154	132		155	169		202	186		215			184
21'	92		147	103		147	115		148	148		193	163	173	205			175
22'	80		136	91		141	101		141	130		184	143	153	196			167
23'	71		124	80		135	90		135	115		176	127	135	187			160
24'	63		114	71		129	80		130	102		169	112	120	179			153
25'	56		105	63		124	71		125	91		162	100	107	172			147
26'	50		97	56	113	117	63		120	82		156	90	96	166			142
27'	45		90	51	102	108	57	114	115	74	148	150	81	87	160			137
28'	40	81	84	46	92	101	51	103	111	66	133	145	73	146	154	78		132
29'	36	73	78	41	83	94	46	93	107	60	120	140	66	132	149	71		127
30'	33	66	73	37	75	88	42	85	104	54	109	135	60	120	144	64		123
31'	30	60	68	34	68	82	38	77	101	50	100	131	54	109	139	59	118	119
32'	27	55	64	31	62	77	35	70	97	45	91	124	49	99	135	53	107	115
33'	25	50	60	28	57	73	32	64	94	41	83	117	45	91	131	49	98	112
34'	23	46	57	26	52	68	29	59	92	38	76	110	41	83	127	45	90	109

Design Assumptions:

- Span is the clear distance between supports and is valid for simple or continuous span applications. Continuous spans are based on the longest span. The shortest span shall not be less than 50% of the longest span.
- The values in the tables are for uniform loads only.
- Factored Total Load resistance is for standard (100%) load duration.
- These tables do not reflect any additional stiffness provided by the sheathing.
- Live L/360 Deflection resistance is limited to L/360. Vibration has not been considered.
- Total L/180 Deflection resistance is limited to L/180. Long term deflection (creep) has not been considered.
- These tables assume full lateral support of the compression flange. Full support is considered to be a maximum unbraced length of 24'.
- These tables are based on an end bearing length of at least 1-3/4" and an interior bearing length of at least 3-1/2," and are limited to the bearing capacity for an SPF wall plate.

Additional Notes:

- These tables have been designed to meet the Limit States Design requirements of the National Building Code of Canada.
- The tabulated resistances represent the capacity of the member in pounds per lineal foot (plf) of length.
- For roofs with a pitch of 2:12 or greater, the horizontal span shall be multiplied by the appropriate pitch adjustment factor from the table at the bottom of this page. Roof joists shall have a minimum pitch of 1/4" per foot (1/4:12) for positive drainage.
- The designer shall check the Factored Total Load, the Total L/180 Deflection and the Live L/360 Deflection resistance columns.
- To design for an L/240 live load deflection, multiply the Live L/360 Deflection values by 1.5. To design for a L/480 live load deflection, multiply the Live L/360 Deflection values by 0.75 or refer to the Uniform Floor Load (PLF) Tables on page 10.
- Where the Deflection resistance is blank, the Factored Total Load resistance governs the design.
- To design a double I-Joist, the values in these tables can be doubled, or the design loads on the I-Joist may be halved to verify the capacity of each ply. The capacity is additive.
- Web stiffeners are not required for these spans and loads.
- Web fillers are required for I-Joists seated in hangers that do not laterally support the top flange or for hangers that require nailing into the web.
- Do not use a product where designated "-" without further analysis by a design professional.

ROOF PITCH ADJUSTMENT FACTORS

Roof Pitch	2:12	3:12	4:12	5:12	6:12	7:12	8:12	9:12	10:12	11:12	12:12
Factor	1.014	1.031	1.054	1.083	1.118	1.158	1.202	1.250	1.302	1.357	1.414

Roof Span Tables: Low Pitch (6:12 or less)

20, 25 and 30 psf Load

SPECIFIED ROOF LIVE OR SNOW LOAD (STANDARD DURATION) – 20 PSF ROOF LIVE OR SNOW

Series	Depth	16" oc		19.2" oc		24" oc	
Specified Dead Load →		15 psf	20 psf	15 psf	20 psf	15 psf	20 psf
PWI 18S, LPI 18	9-1/2"	18-9"	18-5"	17-7"	17-3"	16-4"	15-8"
	11-7/8"	22-8"	20-11"	20-8"	19-1"	18-5"	17-1"
	14"	20-6"	20-1"	19-3"	18-10"	17-10"	17-5"
PWI 20S, LPI 20Plus	9-1/2"	24-7"	24-1"	23-1"	22-8"	21-4"	20-3"
	11-7/8"	28-1"	26-11"	26-5"	24-7"	23-9"	21-11"
	14"	31-2"	28-11"	28-5"	26-4"	25-5"	23-6"
PWI 32S, LPI 32Plus	9-1/2"	21-9"	21-4"	20-5"	20-0"	18-10"	18-6"
	11-7/8"	26-0"	25-5"	24-4"	23-11"	22-7"	21-9"
	14"	29-6"	28-11"	27-9"	26-9"	25-8"	23-11"
PWI 36L, LPI 36	9-1/2"	32-8"	31-8"	30-8"	28-10"	27-10"	25-9"
	11-7/8"	27-2"	26-8"	25-6"	25-0"	23-7"	23-2"
	14"	30-9"	30-2"	28-11"	28-4"	26-9"	26-3"
PWI 42S, LPI 42Plus	9-1/2"	34-0"	33-4"	31-11"	31-4"	29-7"	27-10"
	11-7/8"	24-8"	24-2"	23-2"	22-8"	21-5"	21-0"
	14"	29-6"	28-11"	27-8"	27-2"	25-7"	25-1"
PWI 52S, LPI 52Plus	9-1/2"	33-6"	32-11"	31-6"	30-10"	29-2"	28-7"
	11-7/8"	30-6"	29-11"	28-8"	28-1"	26-6"	26-0"
	14"	34-7"	33-11"	32-6"	31-10"	30-1"	29-6"
PWI 56L, LPI 56	9-1/2"	38-4"	37-7"	36-0"	35-3"	33-4"	32-8"
	11-7/8"	31-6"	30-11"	29-7"	29-0"	27-5"	26-10"
	14"	35-9"	35-0"	33-6"	32-11"	31-0"	30-5"
	16"	39-5"	38-8"	37-0"	36-4"	34-3"	31-2"

SPECIFIED SNOW LOAD (STANDARD DURATION) – 25 PSF SNOW

Series	Depth	16" oc		19.2" oc		24" oc	
Specified Dead Load →		15 psf	20 psf	15 psf	20 psf	15 psf	20 psf
PWI 18S, LPI 18	9-1/2"	17-4"	17-4"	16-4"	16-4"	15-1"	14-11"
	11-7/8"	21-0"	19-11"	19-3"	18-2"	17-2"	16-3"
	14"	19-0"	19-0"	17-10"	17-10"	16-6"	16-6"
PWI 20S, LPI 20Plus	9-1/2"	22-9"	22-9"	21-4"	21-4"	19-9"	19-4"
	11-7/8"	26-0"	25-8"	24-5"	23-5"	22-2"	20-11"
	14"	29-0"	27-6"	26-7"	25-1"	23-9"	22-5"
PWI 32S, LPI 32Plus	9-1/2"	20-1"	20-1"	18-10"	18-10"	17-5"	17-5"
	11-7/8"	24-0"	24-0"	22-7"	22-7"	20-10"	20-9"
	14"	27-4"	27-4"	25-8"	25-6"	23-9"	22-9"
PWI 36L, LPI 36	9-1/2"	30-3"	30-2"	28-5"	27-6"	26-0"	23-8"
	11-7/8"	25-2"	25-2"	23-7"	23-7"	21-10"	21-10"
	14"	28-6"	28-6"	26-9"	26-9"	24-9"	24-9"
PWI 42S, LPI 42Plus	9-1/2"	31-6"	31-6"	29-7"	29-7"	27-4"	25-0"
	11-7/8"	22-10"	22-10"	21-5"	21-5"	19-10"	19-10"
	14"	27-4"	27-4"	25-7"	25-7"	23-8"	23-8"
PWI 52S, LPI 52Plus	9-1/2"	31-1"	31-1"	29-2"	29-2"	27-0"	27-0"
	11-7/8"	34-5"	34-5"	32-4"	32-4"	29-11"	29-11"
	14"	28-3"	28-3"	26-6"	26-6"	24-6"	24-6"
PWI 56L, LPI 56	9-1/2"	32-0"	32-0"	30-1"	30-1"	27-10"	27-10"
	11-7/8"	35-6"	35-6"	33-4"	33-4"	30-10"	30-10"
	14"	29-2"	29-2"	27-5"	27-5"	25-4"	25-4"
	16"	33-1"	33-1"	31-0"	31-0"	28-9"	28-2"
	16"	36-6"	36-6"	34-3"	34-3"	31-8"	28-3"

SPECIFIED SNOW LOAD (STANDARD DURATION) – 30 PSF SNOW

Series	Depth	16" oc		19.2" oc		24" oc	
Specified Dead Load →		15 psf	20 psf	15 psf	20 psf	15 psf	20 psf
PWI 18S, LPI 18	9-1/2"	16-4"	16-4"	15-4"	15-4"	14-2"	14-1"
	11-7/8"	19-8"	18-11"	18-1"	17-3"	16-2"	15-4"
	14"	17-10"	17-10"	16-8"	16-8"	15-5"	15-5"
PWI 20S, LPI 20Plus	9-1/2"	21-4"	21-4"	20-1"	20-1"	18-6"	18-3"
	11-7/8"	24-5"	24-3"	22-11"	22-2"	20-10"	19-9"
	14"	27-2"	26-0"	25-0"	23-9"	22-4"	21-3"
PWI 32S, LPI 32Plus	9-1/2"	18-10"	18-10"	17-8"	17-8"	16-4"	16-4"
	11-7/8"	22-7"	22-7"	21-2"	21-2"	19-7"	19-7"
	14"	25-8"	25-8"	24-1"	24-1"	22-3"	21-2"
PWI 36L, LPI 36	9-1/2"	28-5"	28-5"	26-8"	26-0"	23-6"	21-3"
	11-7/8"	23-7"	23-7"	22-2"	22-2"	20-6"	20-6"
	14"	26-9"	26-9"	25-1"	25-1"	23-3"	22-3"
PWI 42S, LPI 42Plus	9-1/2"	29-7"	29-7"	27-9"	27-9"	24-6"	22-3"
	11-7/8"	21-5"	21-5"	20-1"	20-1"	18-7"	18-7"
	14"	25-7"	25-7"	24-0"	24-0"	22-3"	22-3"
PWI 52S, LPI 52Plus	9-1/2"	29-2"	29-2"	27-4"	27-4"	25-4"	25-4"
	11-7/8"	32-4"	32-4"	30-4"	30-4"	28-1"	28-1"
	14"	26-6"	26-6"	24-11"	24-11"	23-0"	23-0"
PWI 56L, LPI 56	9-1/2"	30-1"	30-1"	28-3"	28-3"	26-2"	26-2"
	11-7/8"	33-4"	33-4"	31-3"	31-3"	28-11"	28-11"
	14"	27-5"	27-5"	25-8"	25-8"	23-9"	23-9"
	16"	31-0"	31-0"	29-2"	29-2"	26-11"	25-3"
	16"	34-3"	34-3"	32-2"	31-9"	28-0"	25-4"

Table Usage:

1. Select the appropriate set of tables based on roof pitch.
2. Select the section of that table that corresponds to the specified roof live or snow load.
3. Find a span that meets or exceeds the design span for the appropriate specified roof dead load (15 psf or 20 psf).
4. Read the corresponding series, depth and spacing.

Design Assumptions:

1. The spans listed are the horizontal clear distance between supports and are valid for simple or continuous span applications. Continuous spans are based on the longest span. The shortest span shall not be less than 50% of the longest span.
2. The spans are based on uniform gravity loads only as listed for each table, including the effects of a 300 lb concentrated load. These spans have not been evaluated for wind.
3. These tables do not reflect any additional stiffness provided by the roof sheathing.
4. Live load deflection is limited to L/360.
5. Total load deflection is limited to L/180.
6. The spans are based on an end bearing length of at least 1-3/4" and an interior bearing length of at least 3-1/2," and are limited to the bearing capacity for an SPF wall plate.
7. These tables assume full lateral support of the compression flange. Full support is considered to be a maximum unbraced length of 24".

Additional Notes:

1. Web stiffeners are not required for the Roof Span tables except when using a "bird's mouth" detail for the low-end bearing.
2. Web fillers are required for I-joists seated in hangers that do not laterally support the top flange or for hangers that require nailing into the web.
3. L/360 represents the maximum deflection allowed per code for roof joists supporting plaster or gypsum ceilings. Verify deflection limits with local code requirements.
4. Roof joists must have a minimum pitch of 1/4" per foot (1/4:12) for positive drainage.
5. Roof applications in high wind areas require special analysis which may reduce spans and may require bracing of the bottom flange and special connectors to resist uplift.
6. For conditions not shown, use the Uniform Roof Load (PLF) tables, use the Exacte by PWT software or contact your PWT™ distributor for assistance.

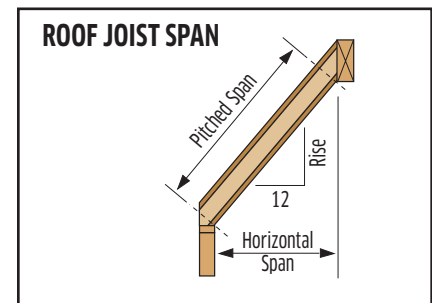

ACTUAL DEFLECTION BASED ON SPAN AND LIMIT

Span (ft)	L/360	L/240	L/180
10'	5/16"	1/2"	11/16"
12'	3/8"	5/8"	13/16"
14'	7/16"	11/16"	15/16"
16'	9/16"	13/16"	1-1/16"
18'	5/8"	7/8"	1-3/16"
20'	11/16"	1"	1-5/16"
22'	3/4"	1-1/8"	1-7/16"
24'	13/16"	1-3/16"	1-5/8"
26'	7/8"	1-5/16"	1-3/4"
28'	15/16"	1-3/8"	1-7/8"
30'	1"	1-1/2"	2"

* Deflections rounded to the nearest 1/16."

Roof Span Tables: Low Pitch (6:12 or less)

40, 50 and 60 psf Load

SPECIFIED SNOW LOAD (STANDARD DURATION) – 40 PSF SNOW

Series	Depth	16" oc		19.2" oc		24" oc	
		15 psf	20 psf	15 psf	20 psf	15 psf	20 psf
PWI 18S, LPI 18	9-1/2"	14-9"	14-9"	13-10"	13-10"	12-9"	12-9"
	11-7/8"	17-10"	17-2"	16-4"	15-8"	14-7"	14-0"
	16"	20-11"	19-8"	17-5"	16-4"	13-10"	13-0"
PWI 20S, LPI 20Plus	9-1/2"	16-1"	16-1"	15-1"	15-1"	13-11"	13-11"
	11-7/8"	19-4"	19-4"	18-1"	18-1"	16-9"	16-7"
	16"	22-1"	22-1"	20-9"	20-2"	18-9"	17-6"
PWI 32S, LPI 32Plus	9-1/2"	17-1"	17-1"	16-0"	16-0"	14-9"	14-9"
	11-7/8"	20-5"	20-5"	19-1"	19-1"	17-8"	17-1"
	16"	23-2"	23-2"	21-9"	21-9"	19-0"	17-6"
PWI 36L, LPI 36	11-7/8"	21-4"	21-4"	20-0"	20-0"	18-6"	18-4"
	14"	24-2"	24-2"	22-8"	22-8"	19-9"	18-4"
	16"	26-9"	26-9"	24-9"	22-11"	19-9"	18-4"
PWI 42S, LPI 42Plus	9-1/2"	19-4"	19-4"	18-2"	18-2"	16-9"	16-9"
	11-7/8"	23-2"	23-2"	21-9"	21-9"	20-1"	20-1"
	16"	26-4"	26-4"	24-9"	24-9"	22-10"	22-10"
PWI 52S, LPI 52Plus	11-7/8"	24-0"	24-0"	22-6"	22-6"	20-10"	20-10"
	14"	27-3"	27-3"	25-7"	25-7"	23-8"	23-8"
	16"	30-2"	30-2"	28-4"	28-4"	26-2"	25-4"
PWI 56L, LPI 56	11-7/8"	24-9"	24-9"	23-3"	23-3"	21-6"	20-10"
	14"	28-1"	28-1"	26-4"	26-2"	22-9"	20-11"
	16"	31-0"	31-0"	28-7"	26-3"	22-9"	20-11"

SPECIFIED SNOW LOAD (STANDARD DURATION) – 50 PSF SNOW

Series	Depth	16" oc		19.2" oc		24" oc	
		15 psf	20 psf	15 psf	20 psf	15 psf	20 psf
PWI 18S, LPI 18	9-1/2"	13-8"	13-8"	12-9"	12-9"	11-10"	11-10"
	11-7/8"	16-5"	15-10"	15-0"	14-5"	13-4"	12-11"
	16"	19-2"	17-10"	16-9"	16-9"	15-5"	14-6"
PWI 20S, LPI 20Plus	9-1/2"	14-10"	14-10"	13-11"	13-11"	12-10"	12-10"
	11-7/8"	17-10"	17-10"	16-9"	16-9"	15-5"	14-6"
	16"	20-5"	20-5"	19-2"	18-7"	16-0"	14-11"
PWI 32S, LPI 32Plus	9-1/2"	15-9"	15-9"	14-9"	14-9"	13-8"	13-7"
	11-7/8"	18-10"	18-10"	17-8"	17-8"	15-5"	14-6"
	16"	21-5"	21-5"	20-1"	18-8"	16-0"	14-11"
PWI 36L, LPI 36	11-7/8"	19-9"	19-9"	18-6"	18-6"	16-7"	15-6"
	14"	22-5"	22-5"	20-9"	19-5"	16-7"	15-6"
	16"	24-9"	23-5"	20-9"	19-5"	16-7"	15-6"
PWI 42S, LPI 42Plus	9-1/2"	17-11"	17-11"	16-9"	16-9"	15-6"	15-6"
	11-7/8"	21-5"	21-5"	20-1"	20-1"	18-6"	18-6"
	16"	24-5"	24-5"	22-10"	22-10"	20-11"	19-7"
PWI 52S, LPI 52Plus	11-7/8"	22-2"	22-2"	20-10"	20-10"	19-3"	19-3"
	14"	25-2"	25-2"	23-8"	23-8"	21-10"	21-5"
	16"	27-11"	27-11"	26-2"	26-2"	23-0"	21-6"
PWI 56L, LPI 56	11-7/8"	22-11"	22-11"	21-6"	21-6"	19-1"	17-9"
	14"	26-0"	26-0"	24-0"	22-4"	19-2"	17-10"
	16"	28-8"	26-11"	24-0"	22-5"	19-2"	17-10"

SPECIFIED SNOW LOAD (STANDARD DURATION) – 60 PSF SNOW

Series	Depth	16" oc		19.2" oc		24" oc	
		15 psf	20 psf	15 psf	20 psf	15 psf	20 psf
PWI 18S, LPI 18	9-1/2"	12-9"	12-9"	12-0"	12-0"	11-1"	10-7"
	11-7/8"	15-3"	14-10"	13-11"	13-6"	11-11"	11-3"
	16"	18-0"	16-9"	15-8"	15-8"	13-3"	12-7"
PWI 20S, LPI 20Plus	9-1/2"	13-11"	13-11"	13-1"	13-1"	12-0"	11-10"
	11-7/8"	16-9"	16-9"	15-8"	15-8"	13-3"	12-7"
	16"	19-2"	19-1"	17-4"	16-3"	13-9"	12-11"
PWI 32S, LPI 32Plus	9-1/2"	14-9"	14-9"	13-10"	13-10"	12-6"	11-10"
	11-7/8"	17-8"	17-8"	16-7"	15-9"	13-3"	12-7"
	16"	20-11"	19-8"	17-5"	16-4"	13-10"	13-0"
PWI 36L, LPI 36	11-7/8"	18-6"	18-6"	17-4"	16-11"	14-3"	13-5"
	14"	21-0"	20-4"	17-10"	16-11"	14-3"	13-5"
	16"	21-6"	20-4"	17-10"	16-11"	14-3"	13-5"
PWI 42S, LPI 42Plus	9-1/2"	16-9"	16-9"	15-8"	15-8"	14-6"	14-6"
	11-7/8"	20-1"	20-1"	18-10"	18-10"	17-4"	16-4"
	16"	22-10"	22-10"	21-5"	21-4"	18-0"	17-0"
PWI 52S, LPI 52Plus	11-7/8"	20-10"	20-10"	19-6"	19-6"	18-0"	18-0"
	14"	23-8"	23-8"	22-2"	22-2"	19-8"	18-7"
	16"	26-2"	26-2"	24-7"	23-5"	19-9"	18-8"
PWI 56L, LPI 56	11-7/8"	21-6"	21-6"	20-1"	19-5"	16-6"	15-6"
	14"	24-4"	23-5"	20-8"	19-5"	16-6"	15-6"
	16"	24-11"	23-5"	20-9"	19-6"	16-6"	15-6"

Table Usage:

1. Select the appropriate set of tables based on roof pitch.
2. Select the section of that table that corresponds to the specified roof live or snow load.
3. Find a span that meets or exceeds the design span for the appropriate specified roof dead load (15 psf or 20 psf).
4. Read the corresponding series, depth and spacing.

Design Assumptions:

1. The spans listed are the horizontal clear distance between supports and are valid for simple or continuous span applications. Continuous spans are based on the longest span. The shortest span shall not be less than 50% of the longest span.
2. The spans are based on uniform gravity loads only as listed for each table, including the effects of a 300 lb concentrated load. These spans have not been evaluated for wind.
3. These tables do not reflect any additional stiffness provided by the roof sheathing.
4. Live load deflection is limited to L/360.
5. Total load deflection is limited to L/180.
6. The spans are based on an end bearing length of at least 1-3/4" and an interior bearing length of at least 3-1/2," and are limited to the bearing capacity for an SPF wall plate.
7. These tables assume full lateral support of the compression flange. Full support is considered to be a maximum unbraced length of 24".

Additional Notes:

1. Web stiffeners are not required for the Roof Span tables except when using a "bird's mouth" detail for the low-end bearing.
2. Web fillers are required for I-joists seated in hangers that do not laterally support the top flange or for hangers that require nailing into the web.
3. L/360 represents the maximum deflection allowed per code for roof joists supporting plaster or gypsum ceilings. Verify deflection limits with local code requirements.
4. Roof joists must have a minimum pitch of 1/4" per foot (1/4:12) for positive drainage.
5. Roof applications in high wind areas require special analysis which may reduce spans and may require bracing of the bottom flange and special connectors to resist uplift.
6. For conditions not shown, use the Uniform Roof Load (PLF) tables, use the Exact by PWT software or contact your PWT™ distributor for assistance.

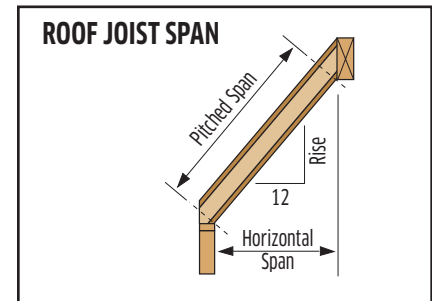

ACTUAL DEFLECTION BASED ON SPAN AND LIMIT

Span (ft)	L/360	L/240	L/180
10'	5/16"	1/2"	11/16"
12'	3/8"	5/8"	13/16"
14'	7/16"	11/16"	15/16"
16'	9/16"	13/16"	1-1/16"
18'	5/8"	7/8"	1-3/16"
20'	11/16"	1"	1-5/16"
22'	3/4"	1-1/8"	1-7/16"
24'	13/16"	1-3/16"	1-5/8"
26'	7/8"	1-5/16"	1-3/4"
28'	15/16"	1-3/8"	1-7/8"
30'	1"	1-1/2"	2"

* Deflections rounded to the nearest 1/16."

Roof Span Tables: High Pitch (6:12 to 12:12)

20, 25 and 30 psf Load

SPECIFIED ROOF LIVE OR SNOW LOAD (STANDARD DURATION) – 20 PSF ROOF LIVE OR SNOW

Series	Depth	16" oc		19.2" oc		24" oc	
		15 psf	20 psf	15 psf	20 psf	15 psf	20 psf
PWI 18S, LPI 18	9-1/2"	17'-3"	16'-4"	16'-2"	15'-4"	15'-0"	14'-2"
	11-7/8"	20'-9"	19'-2"	19'-6"	17'-6"	17'-5"	15'-7"
	14"	25'-10"	24'-5"	24'-3"	22'-6"	22'-4"	20'-1"
PWI 20S, LPI 20Plus	9-1/2"	18'-10"	17'-10"	17'-8"	16'-9"	16'-4"	15'-6"
	11-7/8"	22'-7"	21'-5"	21'-2"	20'-1"	19'-8"	18'-7"
	14"	25'-10"	24'-5"	24'-3"	22'-6"	22'-4"	20'-1"
PWI 32S, LPI 32Plus	9-1/2"	19'-11"	18'-11"	18'-9"	17'-9"	17'-4"	16'-5"
	11-7/8"	23'-10"	22'-7"	22'-5"	21'-2"	20'-9"	19'-8"
	14"	27'-1"	25'-8"	25'-6"	24'-1"	23'-7"	21'-10"
PWI 36L, LPI 36	9-1/2"	24'-11"	23'-8"	23'-5"	22'-2"	21'-8"	20'-7"
	11-7/8"	28'-3"	26'-9"	26'-7"	25'-2"	24'-7"	23'-3"
	14"	31'-3"	29'-7"	29'-4"	27'-9"	27'-2"	23'-4"
PWI 42S, LPI 42Plus	9-1/2"	22'-8"	21'-5"	21'-3"	20'-1"	19'-8"	18'-8"
	11-7/8"	27'-1"	25'-8"	25'-5"	24'-1"	23'-7"	22'-4"
	14"	30'-9"	29'-2"	28'-11"	27'-5"	26'-10"	25'-4"
PWI 52S, LPI 52Plus	9-1/2"	28'-0"	26'-6"	26'-3"	24'-11"	24'-4"	23'-1"
	11-7/8"	31'-9"	30'-1"	29'-10"	28'-3"	27'-8"	26'-2"
	14"	35'-2"	33'-4"	33'-0"	31'-3"	30'-7"	29'-0"
PWI 56L, LPI 56	9-1/2"	28'-11"	27'-5"	27'-2"	25'-9"	25'-2"	23'-10"
	11-7/8"	32'-10"	31'-1"	30'-10"	29'-2"	28'-6"	26'-1"
	14"	36'-3"	34'-4"	34'-0"	32'-3"	31'-6"	26'-2"

SPECIFIED SNOW LOAD (STANDARD DURATION) – 25 PSF SNOW

Series	Depth	16" oc		19.2" oc		24" oc	
		15 psf	20 psf	15 psf	20 psf	15 psf	20 psf
PWI 18S, LPI 18	9-1/2"	16'-1"	15'-9"	15'-2"	14'-10"	14'-0"	13'-8"
	11-7/8"	19'-5"	18'-8"	18'-3"	17'-0"	16'-5"	15'-2"
	14"	22'-8"	21'-1"	20'-8"	19'-5"	18'-4"	18'-0"
PWI 20S, LPI 20Plus	9-1/2"	17'-7"	17'-3"	16'-6"	16'-2"	15'-4"	15'-0"
	11-7/8"	21'-1"	20'-8"	19'-10"	19'-5"	18'-4"	18'-0"
	14"	24'-2"	23'-8"	22'-8"	21'-10"	21'-0"	19'-6"
PWI 32S, LPI 32Plus	9-1/2"	26'-11"	25'-8"	25'-3"	23'-5"	22'-8"	20'-8"
	11-7/8"	18'-8"	18'-3"	17'-6"	17'-2"	16'-3"	15'-10"
	14"	22'-4"	21'-10"	20'-11"	20'-6"	19'-5"	19'-0"
PWI 36L, LPI 36	9-1/2"	25'-4"	24'-10"	23'-10"	23'-4"	22'-1"	20'-7"
	11-7/8"	28'-1"	27'-6"	26'-5"	25'-8"	24'-3"	20'-8"
	14"	32'-11"	32'-2"	30'-11"	30'-3"	28'-8"	28'-0"
PWI 42S, LPI 42Plus	9-1/2"	23'-4"	22'-10"	21'-11"	21'-5"	20'-4"	19'-10"
	11-7/8"	26'-6"	25'-11"	24'-10"	24'-4"	23'-0"	21'-11"
	14"	29'-3"	28'-7"	27'-5"	26'-10"	25'-5"	22'-0"
PWI 52S, LPI 52Plus	9-1/2"	21'-2"	20'-9"	19'-11"	19'-5"	18'-5"	18'-0"
	11-7/8"	25'-4"	24'-9"	23'-10"	23'-3"	22'-0"	21'-7"
	14"	28'-10"	28'-2"	27'-1"	26'-6"	25'-1"	24'-6"
PWI 56L, LPI 56	9-1/2"	32'-0"	31'-3"	30'-0"	29'-5"	27'-10"	27'-2"
	11-7/8"	26'-2"	25'-7"	24'-7"	24'-1"	22'-9"	22'-3"
	14"	29'-9"	29'-1"	27'-11"	27'-4"	25'-10"	25'-4"

SPECIFIED SNOW LOAD (STANDARD DURATION) – 30 PSF SNOW

Series	Depth	16" oc		19.2" oc		24" oc	
		15 psf	20 psf	15 psf	20 psf	15 psf	20 psf
PWI 18S, LPI 18	9-1/2"	15'-2"	15'-2"	14'-3"	14'-3"	13'-2"	13'-2"
	11-7/8"	18'-3"	18'-0"	17'-2"	16'-5"	15'-6"	14'-8"
	14"	21'-6"	20'-8"	19'-8"	18'-8"	17'-3"	17'-3"
PWI 20S, LPI 20Plus	9-1/2"	16'-6"	16'-6"	15'-6"	15'-6"	14'-4"	14'-4"
	11-7/8"	19'-10"	19'-10"	18'-8"	18'-8"	17'-3"	17'-3"
	14"	22'-8"	22'-8"	21'-4"	21'-1"	19'-9"	18'-10"
PWI 32S, LPI 32Plus	9-1/2"	25'-3"	24'-10"	23'-9"	22'-7"	21'-5"	19'-3"
	11-7/8"	17'-6"	17'-6"	16'-6"	16'-6"	15'-3"	15'-3"
	14"	20'-11"	20'-11"	19'-8"	19'-8"	18'-2"	18'-2"
PWI 36L, LPI 36	9-1/2"	23'-10"	23'-10"	22'-4"	22'-4"	20'-8"	19'-2"
	11-7/8"	26'-5"	26'-5"	24'-9"	24'-2"	21'-8"	19'-3"
	14"	29'-3"	28'-7"	27'-5"	26'-10"	25'-5"	22'-0"
PWI 42S, LPI 42Plus	9-1/2"	21'-11"	21'-11"	20'-7"	20'-7"	19'-1"	19'-1"
	11-7/8"	24'-7"	24'-7"	23'-1"	23'-1"	21'-5"	21'-5"
	14"	27'-11"	27'-11"	26'-3"	26'-3"	24'-3"	24'-3"
PWI 52S, LPI 52Plus	9-1/2"	30'-0"	30'-0"	28'-2"	28'-2"	26'-1"	26'-1"
	11-7/8"	30'-11"	30'-11"	29'-0"	29'-0"	26'-11"	26'-11"
	14"	33'-11"	33'-11"	31'-10"	31'-10"	29'-11"	29'-11"
PWI 56L, LPI 56	9-1/2"	25'-5"	25'-5"	23'-11"	23'-11"	22'-1"	22'-1"
	11-7/8"	28'-10"	28'-10"	27'-1"	27'-1"	25'-1"	22'-11"
	14"	31'-10"	31'-10"	29'-11"	28'-9"	25'-10"	22'-11"

Table Usage:

1. Select the appropriate set of tables based on roof pitch.
2. Select the section of that table that corresponds to the specified roof live or snow load.
3. Find a span that meets or exceeds the design span for the appropriate specified roof dead load (15 psf or 20 psf).
4. Read the corresponding series, depth and spacing.

Design Assumptions:

1. The spans listed are the horizontal clear distance between supports and are valid for simple or continuous span applications. Continuous spans are based on the longest span. The shortest span shall not be less than 50% of the longest span.
2. The spans are based on uniform gravity loads only as listed for each table, including the effects of a 300 lb concentrated load. These spans have not been evaluated for wind.
3. These tables do not reflect any additional stiffness provided by the roof sheathing.
4. Live load deflection is limited to L/360.
5. Total load deflection is limited to L/180.
6. The spans are based on an end bearing length of at least 1-3/4" and an interior bearing length of at least 3-1/2," and are limited to the bearing capacity for an SPF wall plate.
7. These tables assume full lateral support of the compression flange. Full support is considered to be a maximum unbraced length of 24".

Additional Notes:

1. Web stiffeners are not required for the Roof Span tables except when using a "bird's mouth" detail for the low-end bearing.
2. Web fillers are required for I-joists seated in hangers that do not laterally support the top flange or for hangers that require nailing into the web.
3. L/360 represents the maximum deflection allowed per code for roof joists supporting plaster or gypsum ceilings. Verify deflection limits with local code requirements.
4. Roof joists must have a minimum pitch of 1/4" per foot (1/4:12) for positive drainage.
5. Roof applications in high wind areas require special analysis which may reduce spans and may require bracing of the bottom flange and special connectors to resist uplift.
6. For conditions not shown, use the Uniform Roof Load (PLF) tables, use the Exacte by PWT software or contact your PWT™ distributor for assistance.

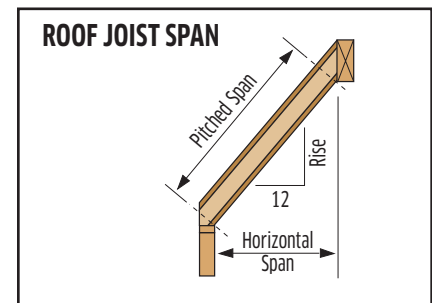

ACTUAL DEFLECTION BASED ON SPAN AND LIMIT

Span (ft)	L/360	L/240	L/180
10'	5/16"	1/2"	11/16"
12'	3/8"	5/8"	13/16"
14'	7/16"	11/16"	15/16"
16'	9/16"	13/16"	1-1/16"
18'	5/8"	7/8"	1-3/16"
20'	11/16"	1"	1-5/16"
22'	3/4"	1-1/8"	1-7/16"
24'	13/16"	1-3/16"	1-5/8"
26'	7/8"	1-5/16"	1-3/4"
28'	15/16"	1-3/8"	1-7/8"
30'	1"	1-1/2"	2"

* Deflections rounded to the nearest 1/16."

Roof Span Tables: High Pitch (6:12 to 12:12)

40, 50 and 60 psf Load

SPECIFIED SNOW LOAD (STANDARD DURATION) – 40 PSF SNOW

Series	Depth	16" oc		19.2" oc		24" oc	
		15 psf	20 psf	15 psf	20 psf	15 psf	20 psf
PWI 18S, LPI 18	9-1/2"	13-8"	13-8"	12-10"	12-10"	11-11"	11-11"
	11-7/8"	16-6"	16-6"	15-6"	15-0"	14-1"	13-5"
	14"	19-0"	19-0"	17-10"	17-10"	16-5"	16-0"
PWI 20S, LPI 20Plus	9-1/2"	14-11"	14-11"	14-0"	14-0"	13-0"	13-0"
	11-7/8"	17-11"	17-11"	16-10"	16-10"	15-7"	15-7"
	14"	20-7"	20-7"	19-3"	19-3"	17-9"	16-1"
PWI 32S, LPI 32Plus	9-1/2"	15-10"	15-10"	14-11"	14-11"	13-9"	13-9"
	11-7/8"	19-0"	19-0"	17-10"	17-10"	16-5"	16-0"
	14"	21-7"	21-7"	20-3"	20-2"	17-9"	16-1"
PWI 36L, LPI 36	9-1/2"	15-10"	15-10"	14-11"	14-11"	13-9"	13-9"
	11-7/8"	19-10"	19-10"	18-8"	18-8"	17-3"	17-1"
	14"	22-6"	22-6"	21-1"	21-1"	18-11"	17-2"
PWI 42S, LPI 42Plus	9-1/2"	18-0"	18-0"	16-11"	16-11"	15-7"	15-7"
	11-7/8"	21-7"	21-7"	20-3"	20-3"	18-8"	18-8"
	14"	24-6"	24-6"	23-0"	23-0"	21-3"	21-3"
PWI 52S, LPI 52Plus	9-1/2"	18-0"	18-0"	16-11"	16-11"	15-7"	15-7"
	11-7/8"	22-3"	22-3"	20-11"	20-11"	19-4"	19-4"
	14"	25-4"	25-4"	23-9"	23-9"	22-0"	22-0"
PWI 56L, LPI 56	9-1/2"	18-0"	18-0"	16-11"	16-11"	15-7"	15-7"
	11-7/8"	23-0"	23-0"	21-7"	21-7"	20-0"	19-3"
	14"	26-1"	26-1"	24-6"	24-2"	21-3"	19-3"

SPECIFIED SNOW LOAD (STANDARD DURATION) – 50 PSF SNOW

Series	Depth	16" oc		19.2" oc		24" oc	
		15 psf	20 psf	15 psf	20 psf	15 psf	20 psf
PWI 18S, LPI 18	9-1/2"	12-8"	12-8"	11-11"	11-11"	11-0"	11-0"
	11-7/8"	15-4"	15-4"	14-4"	13-11"	13-0"	12-4"
	14"	19-0"	19-0"	17-10"	17-5"	15-1"	13-10"
PWI 20S, LPI 20Plus	9-1/2"	13-10"	13-10"	13-0"	13-0"	12-0"	12-0"
	11-7/8"	16-7"	16-7"	15-7"	15-7"	14-5"	13-10"
	14"	19-0"	19-0"	17-10"	17-5"	15-1"	13-10"
PWI 32S, LPI 32Plus	9-1/2"	14-8"	14-8"	13-9"	13-9"	12-9"	12-9"
	11-7/8"	17-7"	17-7"	16-5"	16-5"	15-0"	13-10"
	14"	19-11"	19-11"	18-9"	17-5"	15-1"	13-10"
PWI 36L, LPI 36	9-1/2"	14-8"	14-8"	13-9"	13-9"	12-9"	12-9"
	11-7/8"	18-4"	18-4"	17-3"	17-3"	15-11"	14-9"
	14"	20-10"	20-10"	19-6"	18-7"	16-1"	14-9"
PWI 42S, LPI 42Plus	9-1/2"	16-8"	16-8"	15-7"	15-7"	14-5"	14-5"
	11-7/8"	19-11"	19-11"	18-8"	18-8"	17-3"	17-3"
	14"	22-8"	22-8"	21-3"	21-3"	19-8"	18-8"
PWI 52S, LPI 52Plus	9-1/2"	16-8"	16-8"	15-7"	15-7"	14-5"	14-5"
	11-7/8"	20-8"	20-8"	19-4"	19-4"	17-11"	17-11"
	14"	23-5"	23-5"	22-0"	22-0"	20-4"	20-1"
PWI 56L, LPI 56	9-1/2"	16-8"	16-8"	15-7"	15-7"	14-5"	14-5"
	11-7/8"	21-4"	21-4"	20-0"	20-0"	18-0"	16-7"
	14"	24-2"	24-2"	22-8"	20-10"	18-1"	16-7"

SPECIFIED SNOW LOAD (STANDARD DURATION) – 60 PSF SNOW

Series	Depth	16" oc		19.2" oc		24" oc	
		15 psf	20 psf	15 psf	20 psf	15 psf	20 psf
PWI 18S, LPI 18	9-1/2"	11-11"	11-11"	11-2"	11-2"	10-4"	10-4"
	11-7/8"	14-4"	14-4"	13-6"	13-1"	11-8"	10-10"
	14"	19-0"	19-0"	17-10"	17-5"	15-1"	13-10"
PWI 20S, LPI 20Plus	9-1/2"	13-0"	13-0"	12-2"	12-2"	11-3"	11-3"
	11-7/8"	15-7"	15-7"	14-7"	14-7"	13-1"	12-1"
	14"	17-10"	17-10"	16-6"	15-3"	13-1"	12-2"
PWI 32S, LPI 32Plus	9-1/2"	13-9"	13-9"	12-11"	12-11"	11-11"	11-11"
	11-7/8"	16-5"	16-5"	15-5"	15-3"	13-1"	12-1"
	14"	18-9"	18-5"	16-6"	15-3"	13-1"	12-2"
PWI 36L, LPI 36	9-1/2"	13-9"	13-9"	12-11"	12-11"	11-11"	11-11"
	11-7/8"	17-3"	17-3"	16-2"	16-2"	13-11"	12-11"
	14"	19-6"	19-6"	17-7"	16-3"	14-0"	13-0"
PWI 42S, LPI 42Plus	9-1/2"	15-7"	15-7"	14-8"	14-8"	13-6"	13-6"
	11-7/8"	18-8"	18-8"	17-6"	17-6"	16-2"	15-9"
	14"	21-3"	21-3"	20-0"	20-0"	17-8"	16-5"
PWI 52S, LPI 52Plus	9-1/2"	15-7"	15-7"	14-8"	14-8"	13-6"	13-6"
	11-7/8"	19-4"	19-4"	18-2"	18-2"	16-10"	16-10"
	14"	22-0"	22-0"	20-8"	20-8"	19-1"	17-8"
PWI 56L, LPI 56	9-1/2"	15-7"	15-7"	14-8"	14-8"	13-6"	13-6"
	11-7/8"	20-0"	20-0"	18-9"	18-3"	15-8"	14-6"
	14"	22-8"	22-0"	19-8"	18-3"	15-8"	14-7"

Table Usage:

1. Select the appropriate set of tables based on roof pitch.
2. Select the section of that table that corresponds to the specified roof live or snow load.
3. Find a span that meets or exceeds the design span for the appropriate specified roof dead load (15 psf or 20 psf).
4. Read the corresponding series, depth and spacing.

Design Assumptions:

1. The spans listed are the horizontal clear distance between supports and are valid for simple or continuous span applications. Continuous spans are based on the longest span. The shortest span shall not be less than 50% of the longest span.
2. The spans are based on uniform gravity loads only as listed for each table, including the effects of a 300 lb concentrated load. These spans have not been evaluated for wind.
3. These tables do not reflect any additional stiffness provided by the roof sheathing.
4. Live load deflection is limited to L/360.
5. Total load deflection is limited to L/180.
6. The spans are based on an end bearing length of at least 1-3/4" and an interior bearing length of at least 3-1/2," and are limited to the bearing capacity for an SPF wall plate.
7. These tables assume full lateral support of the compression flange. Full support is considered to be a maximum unbraced length of 24"

Additional Notes:

1. Web stiffeners are not required for the Roof Span tables except when using a "bird's mouth" detail for the low-end bearing.
2. Web fillers are required for I-joists seated in hangers that do not laterally support the top flange or for hangers that require nailing into the web.
3. L/360 represents the maximum deflection allowed per code for roof joists supporting plaster or gypsum ceilings. Verify deflection limits with local code requirements.
4. Roof joists must have a minimum pitch of 1/4" per foot (1/4:12) for positive drainage.
5. Roof applications in high wind areas require special analysis which may reduce spans and may require bracing of the bottom flange and special connectors to resist uplift.
6. For conditions not shown, use the Uniform Roof Load (PLF) tables, use the Exacte by PWT software or contact your PWT™ distributor for assistance.

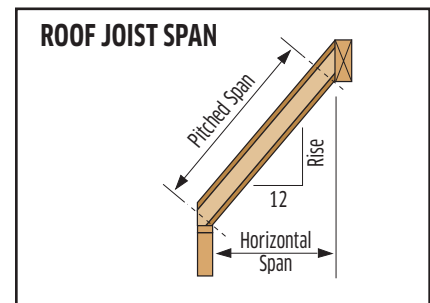

ACTUAL DEFLECTION BASED ON SPAN AND LIMIT

Span (ft)	L/360	L/240	L/180
10'	5/16"	1/2"	11/16"
12'	3/8"	5/8"	13/16"
14'	7/16"	11/16"	15/16"
16'	9/16"	13/16"	1-1/16"
18'	5/8"	7/8"	1-3/16"
20'	11/16"	1"	1-5/16"
22'	3/4"	1-1/8"	1-7/16"
24'	13/16"	1-3/16"	1-5/8"
26'	7/8"	1-5/16"	1-3/4"
28'	15/16"	1-3/8"	1-7/8"
30'	1"	1-1/2"	2"

* Deflections rounded to the nearest 1/16."

Cantilever Details

C1 NO REINFORCEMENT REQUIRED

Min. APA Rated 23/32 OSB (or equal) closure, or as required by code

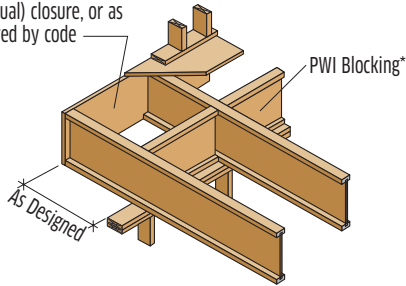

*Rim Board or PWT LVL may be substituted for the PWI Blocking

C1W WEB STIFFENER REQUIRED

Min. APA Rated 23/32 OSB (or equal) closure, or as required by code

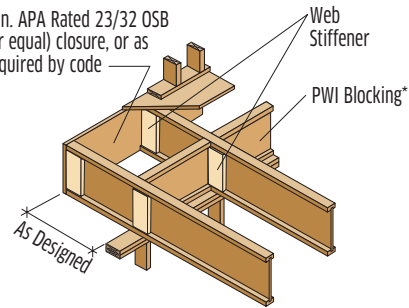

*Rim Board or PWT LVL may be substituted for the PWI Blocking

C2 23/32 OSB (OR EQUAL) REINFORCEMENT ONE SIDE ONLY

Min. APA Rated 23/32 OSB (or equal) closure, or as required by code

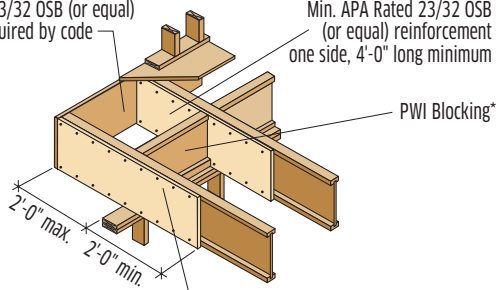

*Rim Board or PWT LVL may be substituted for the PWI Blocking
Attach reinforcement to top and bottom flanges with 8d nails at 6" oc

C3 23/32 OSB (OR EQUAL) REINFORCEMENT BOTH SIDES

Min. APA Rated 23/32 OSB (or equal) closure, or as required by code

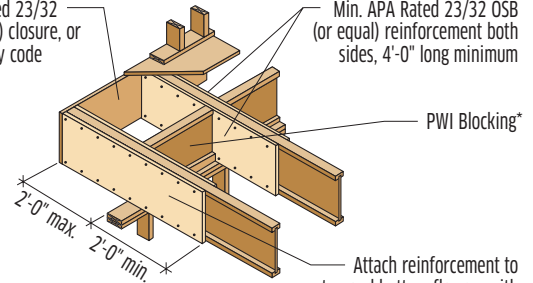

*Rim Board or PWT LVL may be substituted for the PWI Blocking
Attach reinforcement to top and bottom flanges with 8d nails at 6" oc both sides with nails staggered to avoid splitting

C7 BRICK LEDGE CANTILEVER WEB FILLER REINFORCING

Web fillers both sides (refer to table below for size)

Nail web filler with two rows of (3) 10d or (3) 12d box or equivalent gun nails, clinched

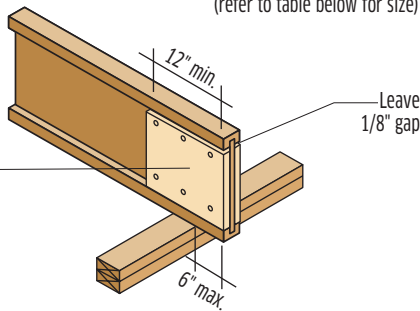

Use construction adhesive between surfaces

Blocking panels are required at the bearing, but are not shown for clarity

BRICK LEDGE CANTILEVER WEB FILLER REINFORCING

Series	Minimum Web Filler	Factored Reaction Resistance (lbs)
PWI 18S, LPI 18	23/32 APA Rated OSB (or equal)	3230
PWI 20S, LPI 20Plus PWI 32S, LPI 32Plus PWI 36L, LPI 36	23/32 APA Rated OSB (or equal)	3660
PWI 42S, LPI 42Plus PWI 52S, LPI 52Plus PWI 56L, LPI 56	1-1/8 APA Rated OSB (or equal)	5630

C8 BRICK LEDGE CANTILEVER FULL-DEPTH REINFORCING ONE SIDE

For 14" and 16" I-Joists, web filler (both sides) and OSB or plywood reinforcing are required (see detail C7).

Nail or screw reinforcing with (3) 6d or 8d box nails or #6 x 1-1/2" wood screws into both flanges*

Construction adhesive is recommended between surfaces

Blocking panels are required at the bearing, but are not shown for clarity

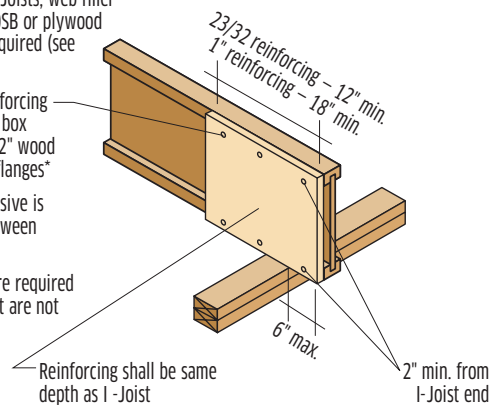

*Note: Pilot holes required when using screws

BRICK LEDGE CANTILEVER FULL-DEPTH REINFORCING

Series	Factored Reaction Resistance (lbs)	
	23/32 APA Rated OSB (or equal)	1" Min. Rim Board
PWI 18S, LPI 18	4360	4780
PWI 20S, LPI 20Plus PWI 32S, LPI 32Plus PWI 36L, LPI 36	4930	5350
PWI 42S, LPI 42Plus PWI 52S, LPI 52Plus PWI 56L, LPI 56	6760	7320

Brick-Ledge Cantilevers

TOTAL JOIST REACTION CALCULATION

PWT™ I-Joists can cantilever up to 6" to support a load-bearing wall over a brick finish. Depending on the Total Joist Reaction (TJR), the joists may require reinforcement. If the TJR is less than the End Reaction Capacity W/out Stiffeners (page 4), then no reinforcement is required. If the TJR is greater than the End Reaction Capacity W/out Stiffeners, but less than the End Reaction Capacity With Stiffeners, then web stiffeners shall be installed at the bearing. Otherwise, one of the reinforcing details shall be used.

Total Joist Reaction, TJR = FLR + WLR + RLR

Where: **FLR** = Floor Load Reaction

WLR = Wall Load Reaction

RLR = Roof Load Reaction, including any other floor, ceiling or attic loads imposed on wall

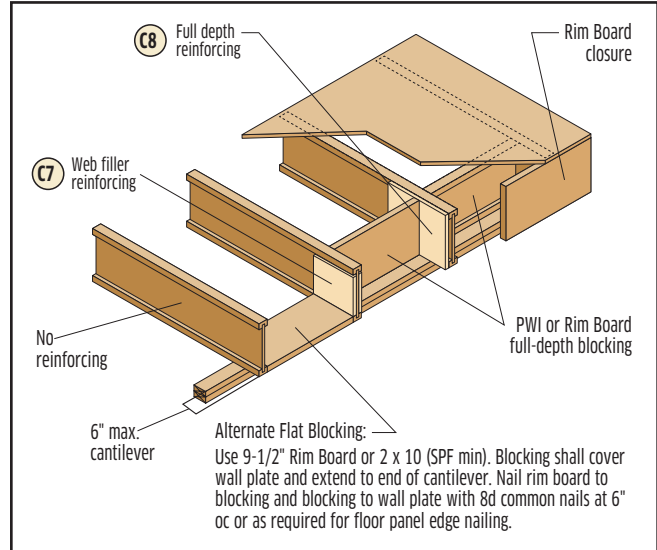

EXAMPLE 1: I-JOIST: 9-1/2" PWI 20S – WALL UNDER CANTILEVER: 3-1/2" WIDE

Specified Design Loads: Floor: 40/10 psf, Roof: 20/10 psf, Wall: 80 plf
Floor System: Joist Span = 16', Joist Cantilever = 5", Joist Spacing = 16" oc
Roof System: Roof Span = 22', Roof Overhang = 1'

Factored FLR = (Joist Span / 2 + Joist Cantilever / 12) * (Factored Floor Load) * (Joist Spacing / 12)
 = (16' / 2 + 5" / 12) * (1.5 * 40 psf + 1.25 * 10 psf) * (16" / 12)
 = 814 lbs

Factored WLR = (Factored Wall Load) * (Joist Spacing / 12)
 = (1.25 * 80 plf) * (16" / 12)
 = 133 lbs

Factored RLR = (Roof Span / 2 + Roof Overhang) * (Factored Roof Load) * (Joist Spacing / 12)
 = (22' / 2 + 1') * (1.5 * 20 psf + 1.25 * 10 psf) * (16" / 12)
 = 680 lbs

Factored TJR = 814 + 133 + 680
 = 1627 lbs

FACTORED END REACTION RESISTANCE

9-1/2" PWI 20S on a 3-1/2" wall	Min. 1-1/2" Bearing	Max. 4" Bearing	3-1/2" Bearing
Without Web Stiffeners	1530	1750	1706
With Web Stiffeners	1800	1990	1952
With Web Filler Reinforcing	-	-	3660
With 23/32 APA Rated OSB Full-Depth Reinforcing (One Side)	-	-	4930
With 1" OSB Rim Full-Depth Reinforcing (One Side)	-	-	5350

Since the Factored Total Joist Reaction, 1627 lbs., is less than the Factored End Reaction Resistance w/out Stiffeners for 3-1/2" bearing (1706 lbs.), no reinforcement is required.

EXAMPLE 1: I-JOIST: 11-7/8" PWI 32S – WALL UNDER CANTILEVER: 3-1/2" WIDE

Specified Design Loads: Floor: 40/15 psf, Roof: 30/15 psf, Wall: 100 plf
Floor System: Joist Span = 16', Joist Cantilever = 5", Joist Spacing = 24" oc
Roof System: Roof Span = 32', Roof Overhang = 1'

Factored FLR = (Joist Span / 2 + Joist Cantilever / 12) * (Factored Floor Load) * (Joist Spacing / 12)
 = (16' / 2 + 5" / 12) * (1.5 * 40 psf + 1.5 * 15 psf) * (24" / 12)
 = 1326 lbs

Factored WLR = (Factored Wall Load) * (Joist Spacing / 12)
 = (1.25 * 100 plf) * (24" / 12)
 = 250 lbs

Factored RL = (Roof Span / 2 + Roof Overhang) * (Factored Roof Load) * (Joist Spacing / 12)
 = (32' / 2 + 1') * (1.5 * 30 psf + 1.25 * 15 psf) * (24" / 12)
 = 2168 lbs

Factored TJR = 1326 + 250 + 2168
 = 3744 lbs

FACTORED END REACTION RESISTANCE

11-7/8" PWI 32S on a 3-1/2" wall	Min. 1-1/2" Bearing	Max. 4" Bearing	3-1/2" Bearing
Without Web Stiffeners	1530	1830	1770
With Web Stiffeners	2010	2345	2278
With Web Filler Reinforcing	-	-	3660
With 23/32 APA Rated OSB Full-Depth Reinforcing (One Side)	-	-	4930
With 1" OSB Rim Full-Depth Reinforcing (One Side)	-	-	5350

Since the Factored Total Joist Reaction, 3744 lbs., is greater than the Factored End Reaction Resistance with Web Filler Reinforcing (3660 lbs.), but is less than the Factored End Reaction Resistance with 23/32 APA Rated OSB Full-Depth Reinforcing (4930 lbs.), this joist requires the installation of full-depth reinforcing consisting of a minimum 23/32 APA Rated OSB (or equal) attached to one side (Detail C8) at the bearing.

Web Hole Specifications

Circular Holes

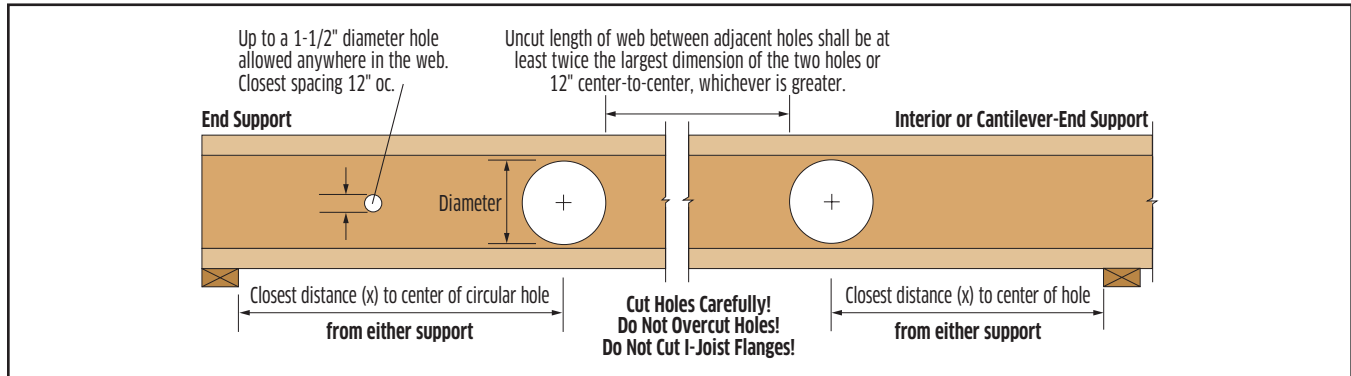

Table Usage:

1. Select the required series and depth.
2. Determine the support condition for the nearest bearing: end support or interior support (including cantilever-end supports).
3. Select the row corresponding to the required Clear Span. For spans between those listed, use the next largest value.
4. Select the column corresponding to the required hole diameter. For diameters between those listed, use the next largest value.
5. The intersection of the Clear Span row and Hole Diameter column gives the minimum distance from the inside face of bearing to the center of a circular hole.
6. Double check the distance to the other support, using the appropriate support condition.

Series	Depth	Clear Span (ft)	Distance from End Support						Distance from Interior or Cantilever-End Support					
			Hole Diameter						Hole Diameter					
			2"	4"	6"	8"	10"	12"	2"	4"	6"	8"	10"	12"
PWI 18S LPI 18	9-1/2"	6	1'-0"	1'-0"	1'-0"	-	-	-	1'-0"	1'-0"	1'-0"	-	-	-
		10	1'-0"	1'-0"	2'-1"	-	-	-	1'-0"	1'-3"	3'-1"	-	-	-
		14	1'-0"	2'-2"	4'-6"	-	-	-	1'-11"	3'-9"	5'-7"	-	-	-
	11-7/8"	18	2'-4"	4'-7"	7'-2"	-	-	-	4'-5"	6'-3"	8'-4"	-	-	-
		10	1'-0"	1'-0"	1'-0"	1'-10"	-	-	1'-0"	1'-0"	1'-3"	3'-0"	-	-
		14	1'-0"	1'-0"	2'-1"	4'-4"	-	-	1'-0"	2'-0"	3'-9"	5'-6"	-	-
PWI 20S LPI 20Plus & PWI 32S LPI 32Plus	9-1/2"	18	1'-0"	2'-5"	4'-6"	6'-11"	-	-	2'-9"	4'-6"	6'-3"	8'-1"	-	-
		22	2'-8"	4'-9"	7'-0"	9'-8"	-	-	5'-3"	7'-0"	8'-9"	11'-0"	-	-
		6	1'-0"	1'-0"	1'-0"	-	-	-	1'-0"	1'-0"	1'-0"	-	-	-
	11-7/8"	10	1'-0"	1'-0"	1'-0"	-	-	-	1'-0"	1'-0"	1'-0"	-	-	-
		14	1'-0"	1'-0"	1'-0"	1'-9"	-	-	1'-0"	1'-0"	2'-1"	3'-5"	-	-
		18	1'-0"	1'-0"	2'-6"	4'-1"	-	-	1'-10"	3'-3"	4'-7"	5'-11"	-	-
	14"	22	1'-0"	3'-2"	4'-10"	6'-7"	-	-	4'-4"	5'-9"	7'-1"	8'-5"	-	-
		14	1'-0"	1'-0"	1'-0"	1'-0"	2'-2"	-	1'-0"	1'-0"	1'-5"	2'-7"	3'-9"	-
		18	1'-0"	1'-0"	1'-9"	3'-8"	-	-	2'-3"	3'-11"	5'-7"	-	-	-
		22	1'-0"	1'-0"	1'-0"	1'-0"	-	-	1'-0"	1'-0"	1'-0"	1'-0"	-	-
		26	3'-8"	5'-0"	6'-5"	8'-0"	9'-8"	-	6'-8"	7'-10"	8'-11"	10'-1"	11'-4"	-
		30	5'-9"	7'-0"	8'-4"	9'-9"	11'-3"	12'-10"	9'-0"	10'-0"	11'-0"	12'-0"	13'-2"	14'-8"
16"	18	1'-0"	1'-0"	1'-4"	2'-5"	3'-7"	4'-11"	1'-6"	2'-6"	3'-6"	4'-6"	5'-6"	6'-6"	
	22	1'-4"	2'-5"	3'-6"	4'-9"	6'-1"	7'-5"	4'-0"	5'-0"	6'-0"	7'-0"	8'-0"	9'-0"	
	26	3'-6"	4'-8"	5'-11"	7'-2"	8'-7"	10'-1"	6'-6"	7'-6"	8'-6"	9'-6"	10'-6"	11'-9"	
	30	5'-9"	7'-0"	8'-4"	9'-9"	11'-3"	12'-10"	9'-0"	10'-0"	11'-0"	12'-0"	13'-2"	14'-8"	
	10	1'-0"	1'-0"	1'-0"	1'-0"	-	-	1'-0"	1'-0"	1'-0"	1'-3"	-	-	
	14	1'-0"	1'-0"	1'-0"	2'-2"	-	-	1'-0"	1'-0"	1'-8"	3'-9"	-	-	
PWI 36L LPI 36 & PWI 56L LPI 56	11-7/8"	18	1'-0"	1'-0"	2'-0"	4'-7"	-	-	1'-0"	2'-1"	4'-2"	6'-3"	-	-
		22	1'-0"	1'-11"	4'-4"	7'-1"	-	-	2'-6"	4'-7"	6'-8"	8'-9"	-	-
		14	1'-0"	1'-0"	1'-0"	1'-0"	2'-10"	-	1'-0"	1'-0"	1'-0"	2'-6"	4'-4"	-
	14"	18	1'-0"	1'-0"	1'-0"	3'-0"	5'-3"	-	1'-0"	1'-5"	3'-3"	5'-0"	6'-10"	-
		22	1'-0"	1'-3"	3'-2"	5'-4"	7'-10"	-	2'-2"	3'-11"	5'-9"	7'-6"	9'-4"	-
		26	1'-5"	3'-5"	5'-6"	7'-10"	10'-6"	-	4'-8"	6'-5"	8'-3"	10'-0"	12'-2"	-
16"	18	1'-0"	1'-0"	1'-0"	2'-0"	3'-10"	5'-11"	1'-0"	1'-0"	2'-7"	4'-1"	5'-8"	7'-3"	
	22	1'-0"	1'-0"	2'-5"	4'-3"	6'-3"	8'-6"	1'-11"	3'-6"	5'-1"	6'-7"	8'-2"	9'-11"	
	26	1'-3"	2'-11"	4'-8"	6'-8"	8'-10"	11'-3"	4'-5"	6'-0"	7'-7"	9'-1"	10'-8"	12'-10"	
PWI 42S LPI 42Plus	9-1/2"	30	3'-4"	5'-2"	7'-1"	9'-2"	11'-5"	14'-0"	6'-11"	8'-6"	10'-1"	11'-7"	13'-5"	
		6	1'-0"	1'-0"	1'-0"	-	-	-	1'-0"	1'-0"	1'-0"	-	-	
		10	1'-0"	1'-0"	1'-0"	-	-	-	1'-0"	1'-0"	1'-0"	-	-	
	11-7/8"	14	1'-0"	1'-0"	1'-5"	-	-	-	1'-0"	1'-5"	3'-1"	-	-	
		18	1'-0"	1'-9"	3'-8"	-	-	-	2'-3"	3'-11"	5'-7"	-	-	
		10	1'-0"	1'-0"	1'-0"	1'-0"	-	-	1'-0"	1'-0"	1'-0"	1'-0"	-	
PWI 42S LPI 42Plus & PWI 52S LPI 52Plus	14"	14	1'-0"	1'-0"	1'-0"	1'-9"	-	-	1'-0"	1'-0"	2'-1"	3'-5"	-	
		18	1'-0"	1'-0"	2'-6"	4'-1"	-	-	1'-10"	3'-3"	4'-7"	5'-11"	-	
		22	1'-8"	3'-2"	4'-10"	6'-7"	-	-	4'-4"	5'-9"	7'-1"	8'-5"	-	
	16"	14	1'-0"	1'-0"	1'-0"	1'-0"	2'-2"	-	1'-0"	1'-0"	1'-5"	2'-7"	3'-9"	-
		18	1'-0"	1'-0"	1'-9"	3'-1"	4'-6"	-	1'-8"	2'-10"	3'-11"	5'-1"	6'-3"	-
		22	1'-5"	2'-9"	4'-1"	5'-6"	7'-0"	-	4'-2"	5'-4"	6'-5"	7'-7"	8'-9"	-
16"	26	3'-8"	5'-0"	6'-5"	8'-0"	9'-8"	-	6'-8"	7'-10"	8'-11"	10'-1"	11'-4"	-	
	18	1'-0"	1'-0"	1'-4"	2'-5"	3'-7"	4'-11"	1'-6"	2'-6"	3'-6"	4'-6"	5'-6"	6'-6"	
	22	1'-4"	2'-5"	3'-6"	4'-9"	6'-1"	7'-5"	4'-0"	5'-0"	6'-0"	7'-0"	8'-0"	9'-0"	
16"	26	3'-6"	4'-8"	5'-11"	7'-2"	8'-7"	10'-1"	6'-6"	7'-6"	8'-6"	9'-6"	10'-6"	11'-9"	
	30	5'-9"	7'-0"	8'-4"	9'-9"	11'-3"	12'-10"	9'-0"	10'-0"	11'-0"	12'-0"	13'-2"	14'-8"	

Design Assumptions:

1. The hole locations are valid for floor joists supporting only uniform loads. The total uniform load shall not exceed 130 plf (e.g., 40 psf Live Load and 25 psf Dead Load spaced 24" oc).
2. Hole location is measured from the inside face of bearing to the center of a circular hole, from the closest support.
3. Clear Span has not been verified for these joists and is shown for informational purposes only! Verify that the joist selected will work for the span and loading conditions needed before checking hole location.
4. The maximum hole depth for circular holes is the I-joist Depth less 4," except the maximum hole depth is 6" for 9-1/2" PWI joists, and 8" for 11-7/8" PWI joists.
5. Holes cannot be located in the span where designated "+", without further analysis by a design professional.

Notes:

1. Holes may be placed anywhere within the depth of the joist. A minimum 1/4" clear distance is recommended between the hole and the flanges.
2. Round holes up to 1-1/2" diameter may be placed anywhere in the web.
3. Perforated "knockouts" may be neglected when locating web holes.
4. Holes larger than 1-1/2" are not permitted in cantilevers without special engineering.
5. Multiple holes shall have a clear separation along the length of the joist of at least twice the larger dimension of the larger adjacent hole, or a minimum of 12" center-to-center, whichever is greater.
6. Multiple holes may be spaced closer provided they fit within the boundary of an acceptable larger hole. Example: two 3" round holes aligned parallel to the joist length may be spaced 2" apart (clear distance) provided that a 3" high by 8" long rectangle or an 8" diameter round hole are acceptable for the joist depth at that location and completely encompass the holes.
7. For conditions not covered in this table, use the Exacte by PWT software or contact your PWT™ distributor for assistance.

Web Hole Specifications

Rectangular Holes

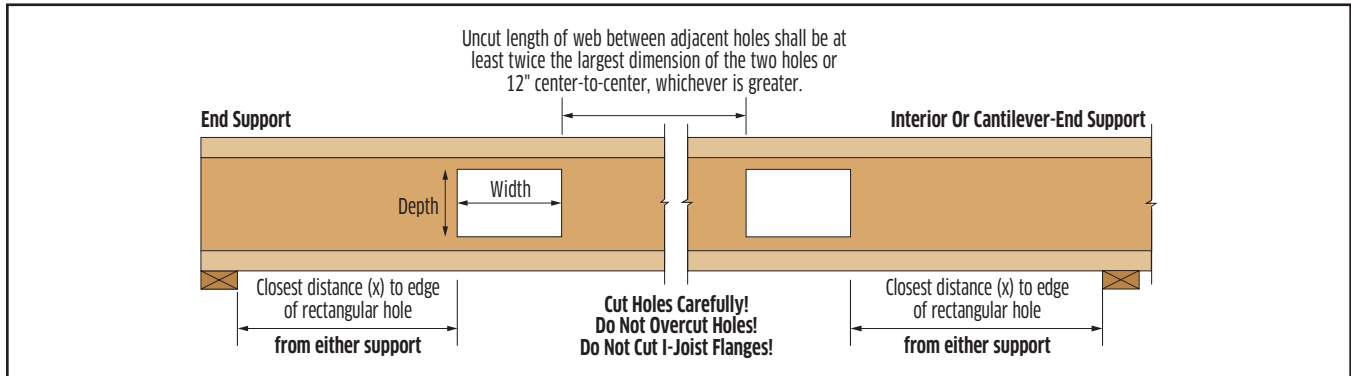

Table Usage:

1. Select the required series and depth.
2. Determine the support condition for the nearest bearing: end support or interior support (including cantilever-end supports).
3. Select the row corresponding to the required Clear Span. For spans between those listed, use the next largest value.
4. Select the column corresponding to the required hole dimension (width or depth). For dimensions between those listed, use the next largest value.
5. The intersection of the Clear Span row and Hole Dimension column gives the minimum distance from the inside face of bearing to the nearest edge of a square or rectangular hole.
6. Double check the distance to the other support, using the appropriate support condition.

Series	Depth	Clear Span (ft)	Distance from End Support						Distance from Interior or Cantilever-End Support					
			Maximum Hole Dimension: Depth or Width						Maximum Hole Dimension: Depth or Width					
			2"	4"	6"	8"	10"	12"	2"	4"	6"	8"	10"	12"
PWI 18S LPI 18	9 1/2"	6	1'-0"	1'-0"	1'-0"	1'-0"	1'-2"	1'-7"	1'-0"	1'-0"	1'-3"	1'-6"	1'-10"	2'-2"
		10	1'-0"	1'-4"	2'-10"	3'-3"	3'-9"	4'-3"	1'-3"	2'-6"	3'-9"	4'-0"	4'-5"	-
		14	2'-2"	3'-8"	5'-5"	5'-11"	6'-6"	-	3'-9"	5'-0"	6'-4"	-	-	-
	11 1/2"	18	4'-7"	6'-3"	8'-2"	-	-	-	6'-3"	7'-6"	-	-	-	-
		10	1'-0"	1'-0"	2'-2"	3'-6"	4'-0"	-	1'-1"	2'-2"	3'-2"	4'-2"	-	-
		14	2'-0"	3'-3"	4'-8"	6'-3"	-	-	3'-7"	4'-8"	5'-8"	-	-	-
		18	4'-4"	5'-9"	7'-3"	-	-	-	6'-1"	7'-2"	8'-5"	-	-	-
		22	6'-10"	8'-4"	10'-1"	-	-	-	8'-7"	9'-9"	-	-	-	-
		PWI 20S LPI 20Plus & PWI 32S LPI 32Plus	9 1/2"	6	1'-0"	1'-0"	1'-0"	1'-0"	1'-0"	1'-5"	1'-0"	1'-0"	1'-3"	1'-8"
10	1'-0"			1'-0"	2'-6"	2'-11"	3'-5"	3'-11"	1'-0"	2'-1"	3'-5"	3'-9"	4'-2"	
14	1'-7"			3'-2"	5'-0"	5'-7"	6'-1"	-	3'-3"	4'-7"	5'-11"	6'-5"	-	
11 1/2"	18		3'-11"	5'-8"	7'-9"	8'-4"	-	-	5'-9"	7'-1"	-	-	-	
	10		1'-0"	1'-0"	1'-9"	3'-3"	3'-9"	4'-3"	1'-0"	1'-9"	2'-10"	4'-0"	4'-5"	
	14		1'-5"	2'-9"	4'-2"	5'-11"	6'-6"	-	3'-1"	4'-3"	5'-4"	-	-	
	18		3'-8"	5'-2"	6'-9"	8'-8"	-	-	5'-7"	6'-9"	7'-11"	-	-	
	22		6'-1"	7'-9"	9'-6"	-	-	-	8'-1"	9'-3"	-	-	-	
	14"		14	1'-0"	1'-0"	1'-0"	2'-8"	4'-11"	5'-9"	1'-0"	1'-0"	2'-6"	4'-2"	5'-10"
18			1'-0"	1'-0"	2'-11"	5'-1"	7'-7"	8'-6"	1'-7"	3'-3"	5'-0"	6'-8"	-	
22			1'-4"	3'-3"	5'-4"	7'-8"	10'-5"	-	4'-1"	5'-9"	7'-6"	9'-2"	-	
26			3'-6"	5'-7"	7'-10"	10'-4"	-	-	6'-7"	8'-3"	10'-0"	12'-0"	-	
30			5'-8"	7'-7"	9'-9"	12'-1"	-	-	8'-11"	10'-6"	12'-0"	14'-0"	-	
16"			10	1'-0"	1'-0"	1'-9"	3'-3"	3'-9"	4'-3"	1'-0"	1'-9"	2'-10"	4'-0"	4'-5"
			14	1'-5"	2'-9"	4'-2"	5'-11"	6'-6"	-	3'-1"	4'-3"	5'-4"	-	-
		18	3'-8"	5'-2"	6'-9"	8'-8"	-	-	5'-7"	6'-9"	7'-11"	-	-	
		22	6'-1"	7'-9"	9'-6"	-	-	-	8'-1"	9'-3"	-	-	-	
	11 1/2"	14	1'-0"	1'-0"	1'-0"	2'-8"	4'-11"	5'-9"	1'-0"	1'-0"	2'-6"	4'-2"	5'-10"	
		18	1'-0"	1'-0"	2'-11"	5'-1"	7'-7"	8'-6"	1'-7"	3'-3"	5'-0"	6'-8"	-	
22		1'-4"	3'-3"	5'-4"	7'-8"	10'-5"	-	4'-1"	5'-9"	7'-6"	9'-2"	-		
PWI 36L LPI 36 & PWI 56L LPI 56	14"	26	3'-6"	5'-7"	7'-10"	10'-4"	-	6'-7"	8'-3"	10'-0"	12'-0"	-		
		30	5'-8"	7'-7"	9'-9"	12'-1"	-	-	8'-11"	10'-6"	12'-0"	14'-0"		
		10	1'-0"	1'-0"	1'-9"	3'-3"	3'-9"	4'-3"	1'-0"	1'-9"	2'-10"	4'-0"	4'-5"	
	16"	14	1'-5"	2'-9"	4'-2"	5'-11"	6'-6"	-	3'-1"	4'-3"	5'-4"	-	-	
		18	3'-8"	5'-2"	6'-9"	8'-8"	-	-	5'-7"	6'-9"	7'-11"	-	-	
		22	6'-1"	7'-9"	9'-6"	-	-	-	8'-1"	9'-3"	-	-	-	
		26	3'-6"	5'-7"	7'-10"	10'-4"	-	-	6'-7"	8'-3"	10'-0"	12'-0"	-	
		30	5'-8"	7'-7"	9'-9"	12'-1"	-	-	8'-11"	10'-6"	12'-0"	14'-0"	-	
		PWI 42S LPI 42Plus	9 1/2"	6	1'-0"	1'-0"	1'-0"	1'-0"	1'-0"	1'-5"	1'-0"	1'-0"	1'-3"	1'-8"
10	1'-0"			1'-0"	2'-6"	2'-11"	3'-5"	3'-11"	1'-0"	2'-1"	3'-5"	3'-9"	4'-2"	
14	1'-7"			3'-2"	5'-0"	5'-7"	6'-1"	-	3'-3"	4'-7"	5'-11"	6'-5"	-	
11 1/2"	18		3'-11"	5'-8"	7'-9"	8'-4"	-	-	5'-9"	7'-1"	-	-	-	
	10		1'-0"	1'-0"	1'-9"	3'-3"	3'-9"	4'-3"	1'-0"	1'-9"	2'-10"	4'-0"	4'-5"	
	14		1'-5"	2'-9"	4'-2"	5'-11"	6'-6"	-	3'-1"	4'-3"	5'-4"	-	-	
	18		3'-8"	5'-2"	6'-9"	8'-8"	-	-	5'-7"	6'-9"	7'-11"	-	-	
	22		6'-1"	7'-9"	9'-6"	-	-	-	8'-1"	9'-3"	-	-	-	
	PWI 42S LPI 42Plus & PWI 52S LPI 52Plus		14"	14	1'-0"	1'-0"	1'-0"	2'-8"	4'-11"	5'-9"	1'-0"	1'-0"	2'-6"	4'-2"
18		1'-0"		1'-0"	2'-11"	5'-1"	7'-7"	8'-6"	1'-7"	3'-3"	5'-0"	6'-8"	-	
22		1'-4"		3'-3"	5'-4"	7'-8"	10'-5"	-	4'-1"	5'-9"	7'-6"	9'-2"	-	
16"		26	3'-6"	5'-7"	7'-10"	10'-4"	-	-	6'-7"	8'-3"	10'-0"	12'-0"	-	
		30	5'-8"	7'-7"	9'-9"	12'-1"	-	-	8'-11"	10'-6"	12'-0"	14'-0"	-	
		10	1'-0"	1'-0"	1'-9"	3'-3"	3'-9"	4'-3"	1'-0"	1'-9"	2'-10"	4'-0"	4'-5"	
		14	1'-5"	2'-9"	4'-2"	5'-11"	6'-6"	-	3'-1"	4'-3"	5'-4"	-	-	
		18	3'-8"	5'-2"	6'-9"	8'-8"	-	-	5'-7"	6'-9"	7'-11"	-	-	
		22	6'-1"	7'-9"	9'-6"	-	-	-	8'-1"	9'-3"	-	-	-	

Design Assumptions:

1. The hole locations are valid for floor joists supporting only uniform loads. The total uniform load shall not exceed 130 plf (e.g., 40 psf Live Load and 25 psf Dead Load spaced 24" oc).
2. Hole location is measured from the inside face of bearing to the nearest edge of a rectangular hole, from the closest support.
3. Clear Span has not been verified for these joists and is shown for informational purposes only! Verify that the joist selected will work for the span and loading conditions needed before checking hole location.
4. The maximum hole depth for rectangular holes is the I-Joist Depth less 4", except the maximum hole depth is 6" for 9-1/2" PWI joists, and 8" for 11-7/8" PWI Joists. Where the Maximum Hole Dimension exceeds the hole depth, the dimension refers to hole width and the depth of the hole is assumed to be the maximum for that joist depth. The maximum hole width is 18", regardless of I-Joist Depth.
5. Holes cannot be located in the span where designated "-", without further analysis by a design professional.

Notes:

1. Holes may be placed anywhere within the depth of the joist. A minimum 1/4" clear distance is recommended between the hole and the flanges.
2. Round holes up to 1-1/2" diameter may be placed anywhere in the web.
3. Perforated "knockouts" may be neglected when locating web holes.
4. Holes larger than 1-1/2" are not permitted in cantilevers without special engineering.
5. Multiple holes shall have a clear separation along the length of the joist of at least twice the larger dimension of the larger adjacent hole, or a minimum of 12" center-to-center, whichever is greater.
6. Multiple holes may be spaced closer provided they fit within the boundary of an acceptable larger hole. Example: two 3" round holes aligned parallel to the joist length may be spaced 2" apart (clear distance) provided that a 3" high by 8" long rectangle or an 8" diameter round hole are acceptable for the joist depth at that location and completely encompass the holes.
7. For conditions not covered in this table, use the Exact by PWT software or contact your PWT™ distributor for assistance.

Floor Details

<p>A1 RIM BOARD</p> <p>Fasten rim board to each floor I-joist using one 8d nail per flange</p> <p>Same depth as I-joist</p> <p>8d nails at 6" oc toe-nailed from outside of building</p>	<p>A2 RIM JOIST</p> <p>Note: Do not use PWI joists with flanges wider than 2-1/2" as rim joists.</p> <p>Rim joists with flanges wider than 1-3/4" require a minimum 2 x 6 plate</p> <p>Fasten rim joist to each floor I-joist with one 10d nail into the end of each flange. Use 16d box nails for rim joists with flanges wider than 1-3/4."</p> <p>8d nails at 6" oc (when used for shear transfer, nail to bearing plate with same nailing schedule for decking)</p>	<p>A3 BLOCKING AT EXTERIOR WALL</p> <p>8d nails at 6" oc (when used for shear transfer, nail to bearing plate with same nailing schedule for decking)</p> <p>OSB or PWT LVL Rim may be substituted for PWI blocking</p>
<p>A4 SOLID BLOCKING AT EXTERIOR WALL</p> <p>OSB or PWT LVL Rim as blocking</p> <p>Same depth as I-joist</p> <p>8d nails at 6" oc toe-nailed from outside of building</p>	<p>A5 JOIST SUPPORT NAILING</p> <p>Secure I-joist to plate with two 8d nails. Drive one nail from each side of I-joist, angled inward.</p> <p>Blocking is required when joists end at support. Blocking may be required at interior supports by project designer or by code for seismic design</p> <p>Place nail 1-1/2" min. from end of I-joist. If nails are close to edge of plate, drive at an angle to reduce splitting</p>	<p>B1 WEB STIFFENERS AT INTERIOR SUPPORT (WHEN REQUIRED)</p> <p>Verify stiffener requirements (see Web Stiffener detail)</p>
<p>B2 SQUASH BLOCKS</p> <p>Blocking panels may be required with shear wall</p> <p>Use double squash blocks as specified. Squash blocks shall be cut 1/16" taller than I-joist. 2 x 4 min.</p> <p>Stagger 8d or 10d nails to avoid splitting</p> <p>Bearing wall aligned under wall above</p> <p>Toe-nail 8d nail to plate</p>	<p>B3 BLOCKING AT INTERIOR SUPPORT</p> <p>Blocking is not required if no wall above unless I-joists end at support. Blocking may be required at interior supports by project designer or by code for seismic design</p> <p>Bearing wall aligned under wall above</p> <p>OSB or PWT LVL Rim may be substituted for PWI blocking</p>	<p>NON-STACKING WALLS</p> <p>OSB or PWT LVL Rim may be substituted for PWI blocking</p> <p>PWT I-joists shall be designed to carry all applied loads including walls from above that do not stack directly over the I-joist support.</p>
<p>D2 POST LOADS</p> <p>Squash blocks required under all post loads</p>	<p>E1 STAIR STRINGER</p> <p>Web filler (as backer block) minimum 12" long</p> <p>Filler block(s) same length as web filler, minimum</p> <p>Approved connection (by others)</p> <p>See I-joist Header Cross-Section for connection information of the filler and backer blocks</p> <p>See I-joist Filler Schedule for filler block and web filler sizes</p>	<p>E2 HANGER DETAIL</p> <p>Verify capacity and fastening requirements of hangers and connectors</p> <p>Verify web filler requirements for hangers</p> <p>Applied loads at end of I-joist must be supported directly by the girder, or by a ledger or blocking fastened to the girder.</p>

Floor Details

E3 I-JOIST HEADER

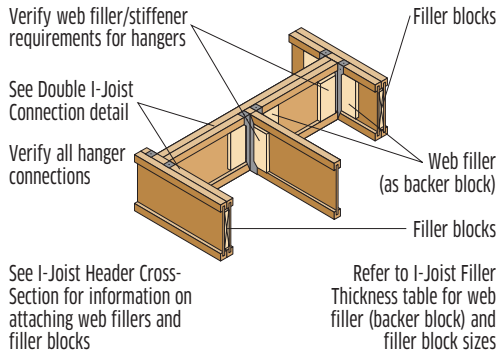

E5 DOUBLE I-JOIST CONNECTION

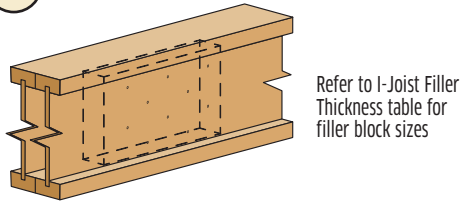

- Filler blocks must be:
- Long enough not to split when nailed (12" min.)
 - Located at each support
 - Under all concentrated loads that are not equally applied to each ply
 - Centered behind each hanger
 - At 24" oc max. under all uniform loads that are not equally applied to each ply
 - Installed tight to top flange at top-mount hangers and top concentrated loads.
 - Installed tight to bottom flange at supports and facemount hangers.

Floor sheathing to be glued and nailed to flanges of both plies

Attach using ten (10) 0.131" x 3-1/4" nails (min.):

- Joists \leq 2-1/2" thick: from either side, total of 10 nails
 - Joists $>$ 2-1/2" thick: from each side, total of 20 nails
- Stagger rows, clinch where possible, and spaced to avoid splitting.

E4 I-JOIST HEADER CROSS SECTION

Filler Blocks: Fasten I-Joists together with filler blocks between the PWI webs:

- Filler blocks must be installed at any load that is not applied to the top of the member and equally to all plies. See Detail E5 for installation instructions.
- For joists supporting only top loads that are equally applied to both plies, filler blocks can be omitted.

Backer Blocks: Minimum 12" long backer blocks must be installed at all hangers and all concentrated loads that are not equally applied to each ply, center backer block on load.

- For a single I-joist header install backer blocks to both sides of the web.
- Backer blocks may be omitted for top-mount hangers supporting only downward loads not exceeding 250 lbs.
- Install backer blocks tight to top flange for top-mount hangers or top concentrated loads. Install tight to bottom flange for face-mount hangers.
- Attach using 10 nails (0.131"x3-1/4" (min.), clinch where possible) spaced to avoid splitting, with half the nails to each side of the center of the supported hanger.
- Face mount hanger nails must be min. 3" long per manufacturer's specifications.

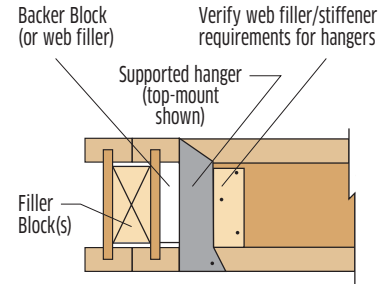

Filler and Backer Blocks:

- Refer to the I-Joist Filler Thickness table for the correct filler and backer block thickness.
- Filler and backer blocks shall consist of APA Rated wood structural panel (OSB or plywood), 2 x lumber (SPF or better), or PWT LVL or OSB Rim Board.
- Filler and backer blocks for members that are top-loaded only, or at hangers that do not require nailing into the web, shall be: at least 5-1/2" deep for I-joists up to 11-7/8" deep and at least 7-1/4" deep for I-joists deeper than 11-7/8". Otherwise, filler blocks shall fit the clear distance between flanges with a gap of at least 1/8", but not more than 1".
- For double PWIs that are not top loaded or have loads that are not applied equally to both plies, the max unfactored loads for standard duration: Concentrated Load = 1200 lbs., Uniform Load = 520 plf. Loads may be increased with more nails and adjusted for other load durations.

Contact the project's design professional or a PWT distributor if these conditions are not met.

Filler Block Depth Example:

Multiple filler blocks may be stacked vertically to achieve the filler depth for a 14" deep I-joist (min. req. is 14" - 3" - 1"=10"). One row of nails must be in each filler.

Backer Block Length Example:

Two pieces, example 2 x 8 (min.) lumber, that are cut to the proper height may be set vertically side-by-side to achieve the required minimum 12" length.

NON LOAD-BEARING CANTILEVER

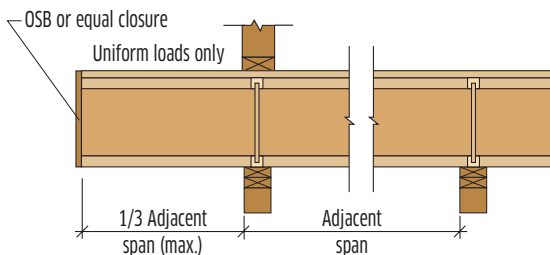

BEVEL CUT/FIRE CUT

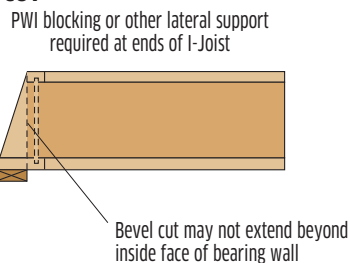

I-JOIST FILLER THICKNESS

Span (ft)	Filler Block	Web Filler/Backer Block
PWI 18S, LPI 18, PWI 20S, LPI 20Plus PWI 32S, LPI 32Plus	2-1/8"	1"
PWI 36L, LPI 36	1-7/8"	7/8"
PWI 42S, LPI 42Plus PWI 52S, LPI 52Plus PWI 56L, LPI 56	3"	1-1/2"

Notes:

1. Backer blocks and filler blocks shall consist of APA Rated wood structural panel (OSB or plywood), or 2x lumber (SPF or better).
2. OSB or PWT LVL Rim may also be used
3. Refer to the Notes for the I-Joist Header Cross-Section above for details on the required height and length, and nailing of the backer blocks and filler blocks.

General Notes:

1. Some wind or seismic loads may require different or additional details and connections.
2. Verify building code requirements for suitability of details shown.
3. Refer to page 4 for bearing length requirements.
4. Refer to page 25 for Flange Face Nailing Schedule for PWI rim joist or blocking panel nailing.
5. Lateral support shall be considered for bottom flange when there is no sheathing on underside.
6. Verify capacity and fastening requirements of hangers and connectors.
7. Squash block capacity designed by others.
8. Do not use PWI joists with flanges wider than 2-1/2" as rim joists.

Roof Details

<p>J1 RAFTER CONNECTION</p> <p>Simpson® LSTA24, MiTek® LSTI-22 strap or equal</p> <p>Beveled plate</p> <p>PWI blocking⁵</p> <p>Support beam or wall</p>	<p>J2 RAFTER CONNECTION WITH FITTED OSB GUSSET</p> <p>23/32 x 2'-0" OSB with 12-8d nails each side min. 1/8" gap at top</p> <p>Beveled plate</p> <p>PWI blocking⁵</p> <p>Support beam or wall</p>	<p>J3 RIDGE RAFTER CONNECTION</p> <p>Web filler required each side</p> <p>Simpson LSTA24, MiTek LSTI-22 strap (or equal) for pitch over 7:12</p> <p>Structural beam</p> <p>Simpson LSSU, MiTek LSSH (or equal) hanger</p>
<p>J4 HEADER CONNECTION</p> <p>Header</p> <p>Simpson LSTA24, MiTek LSTI-22 strap (or equal) for pitch over 7:12</p> <p>Web filler required each side</p> <p>Simpson LSSU, MiTek LSSH (or equal) hanger</p>	<p>H1 BIRD'S MOUTH (LOWER BEARING ONLY)</p> <p>Cut to fit tight to wall plate</p> <p>Don't cut beyond inside face of bearing</p> <p>PWI blocking⁵</p> <p>2'-0" max.</p> <p>Beveled web stiffeners required both sides</p>	<p>H2 BEVELED PLATE</p> <p>PWI blocking⁵</p> <p>2x beveled plate</p> <p>Simpson VPA, MiTek TMP (or equal) connector may be substituted for beveled plate</p>
<p>H3 FLAT SOFFIT (FASCIA SUPPORT)</p> <p>PWI blocking⁵</p> <p>8d nails at 6" oc clinched</p> <p>Beveled plate</p> <p>2 x 4 cut to fit</p> <p>2'-0" max.</p>	<p>H4 OVERHANG</p> <p>8d nails at 6" oc staggered and clinched</p> <p>PWI blocking⁵</p> <p>2 x 4 filler</p> <p>2 x 4 cut to fit both sides</p> <p>4'-0" min.</p> <p>2'-0" max.</p>	<p>H5 OVERHANG</p> <p>8d nails at 6" oc 1" from edge</p> <p>PWI blocking⁵</p> <p>2 x 4 cut to fit</p> <p>Beveled plate</p> <p>Web fillers required both sides of I-Joist</p> <p>8d or 10d box toe-nail to plate</p> <p>2'-0" max.</p>
<p>K1 ROOF OPENING HANGER CONNECTIONS</p> <p>Web stiffener required (see Web Stiffener details)</p> <p>Web filler</p> <p>Filler on back side</p> <p>Install header plumb</p> <p>Filler block</p> <p>Web filler</p>	<p>K2 OUTRIGGER</p> <p>8d nails staggered at 6" oc</p> <p>Maximum overhang same as rafter spacing (2'-0" max.)</p> <p>2 x 4 filler</p> <p>Ladder</p> <p>Gable end</p>	<p>Notes:</p> <ol style="list-style-type: none"> 1. Minimum pitch: 1/4" per foot (1/4:12). Maximum pitch: 12" per foot (12:12). 2. Verify capacity and fastening requirements of hangers and connectors. 3. Some wind or seismic loads may require different or additional details and connections. Uplift anchors may be required. 4. 4" diameter hole(s) may be cut in blocking for ventilation. 5. Lateral resistance shall be provided. Other methods of restraint, such as full depth OSB Rim Board, PWT LVL or metal X-bracing may be substituted for the PWI blocking shown.

Framing Connectors

General Notes:

1. The following tables provide a list of the more common hangers and connectors for use with PWT™ I-Joists.
2. Refer to the manufacturer's connector guide for a complete list of hangers and to verify the suitability of a hanger or connector for a particular application.
3. Follow all connector manufacturers' installation guidelines.

SIMPSON STRONG-TIE®

Series	Depth	Top-Mount		Face-Mount		45° Skewed	Field Slope & Skew	Variable Pitch Seat
		Single	Double	Single	Double	Single	Single	Single
2-1/2" Flange (PWI 18S, LPI 18, PWI 20S, LPI 20Plus, PWI 32S, LPI 32Plus)	9-1/2"	ITS2.56/9.5	MIT39.5-2	IUS2.56/9.5	MIU5.12/9	SUR/L2.56/9	LSSUH310 *	VPA3
	11-7/8"	ITS2.56/11.88	MIT311.88-2	IUS2.56/11.88	MIU5.12/12	SUR/L2.56/11	LSSUH310 *	VPA3
	14"	ITS2.56/14	MIT314-2	IUS2.56/14	MIU5.12/14	SUR/L2.56/14	LSSUH310 *	VPA3
	16"	ITS2.56/16	MIT5.12/16	IUS2.56/16	MIU5.12/16	SUR/L2.56/14 *	**	VPA3
2-1/4" Flange (PWI 36L, LPI 36)	11-7/8"	ITS2.37/11.88	MIT3511.88-2	IUS2.37/11.88	MIU4.75/11	SUR/L2.37/11	LSSU35 *	VPA35
	14"	ITS2.37/14	MIT3514-2	IUS2.37/14	MIU4.75/14	SUR/L2.37/14	LSSU35 *	VPA35
	16"	ITS2.37/16	MIT4.75/16	IUS2.37/16	MIU4.75/16	SUR/L2.37/14 *	**	VPA35
3-1/2" Flange (PWI 42S, LPI 42Plus, PWI 52S, LPI 52Plus, PWI 56L, LPI 56)	9-1/2"	ITS3.56/9.5	B7.12/9.5 *	IUS3.56/9.5	HU410-2 *	SUR/L410 *	LSSU410 *	VPA4
	11-7/8"	ITS3.56/11.88	B7.12/11.88 *	IUS3.56/11.88	HU412-2 *	SUR/L410 *	LSSU410 *	VPA4
	14"	ITS3.56/14	B7.12/14 *	IUS3.56/14	HU414-2 *	SUR/L414 *	LSSU410 *	VPA4
	16"	ITS3.56/16	B7.12/16 *	IUS3.56/16	HU414-2 *	SUR/L414 *	**	VPA4

* Web filler required for proper installation of hanger.

** Refer to Simpson Strong-Tie "Wood Construction Connectors" catalog for hanger selection.

MITEK® STRUCTURAL CONNECTORS

Series	Depth	Top-Mount		Face-Mount		45° Skewed	Field Slope & Skew	Variable Pitch Seat
		Single	Double	Single	Double	Single	Single	Single
2-1/2" Flange (PWI 18S, LPI 18, PWI 20S, LPI 20Plus, PWI 32S, LPI 32Plus)	9-1/2"	TFL2595	THO25950-2 *	THF25925	THF25925-2 *	SKH2520L/R *	LSSH25 *	TMP25 or TMPH25 *
	11-7/8"	TFL25118	THO25118-2 *	THF25112	THF25112-2 *	SKH2520L/R *	LSSH25 *	TMP25 or TMPH25 *
	14"	TFL2514	THO25140-2 *	THF25140	THF25140-2 *	SKH2524L/R *	LSSH25 *	TMP25 or TMPH25 *
	16"	TFL2516	THO25160-2 *	THF25160	THF25160-2 *	SKH2524L/R *	LSSH25 * †	TMP25 or TMPH25 *
2-1/4" Flange (PWI 36L, LPI 36)	11-7/8"	TFL23118	THO23118-2 *	THF23118	THF23118-2 *	SKH2320L/R *	LSSH23 *	TMP23 or TMPH23 *
	14"	TFL2314	THO23140-2 *	THF23140	THF23140-2 *	SKH2324L/R *	LSSH23 *	TMP23 or TMPH23 *
	16"	TFL2316	THO23160-2 *	THF23160	THF23160-2 *	SKH2324L/R *	LSSH23 * †	TMP23 or TMPH23 *
3-1/2" Flange (PWI 42S, LPI 42Plus, PWI 52S, LPI 52Plus, PWI 56L, LPI 56)	9-1/2"	THO35950	BPH7195 *	THF35925	HD7100 *	SKH410L/R **	LSSH35 *	TMP4 or TMPH4 *
	11-7/8"	THO35118	BPH71118 *	THF35112	HD7120 *	SKH410L/R **	LSSH35 *	TMP4 or TMPH4 *
	14"	THO35140	BPH7114 *	THF35140	HD7140 *	SKH414L/R **	LSSH35 *	TMP4 or TMPH4 *
	16"	THO35160	BPH7116 *	THF35157	HD7160 *	SKH414L/R **	LSSH35 * †	TMP4 or TMPH4 *

* Web filler required for proper installation of hanger.

** Miter cut required on end of joist.

† Hanger height is less than 60% of the joist depth. Supplemental lateral support of the top flange is required. Refer to Mitek's installation instructions.

1. Use TMP seats for joist pitch of 1:12 to 6:12. Use TMPH for joist pitch of 6:12 and greater.

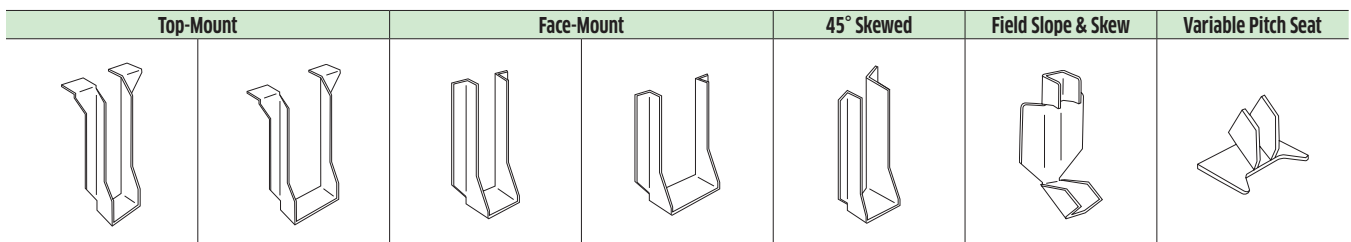

Web Stiffeners, Rim & Blocking, Nailing

WEB STIFFENER DETAILS

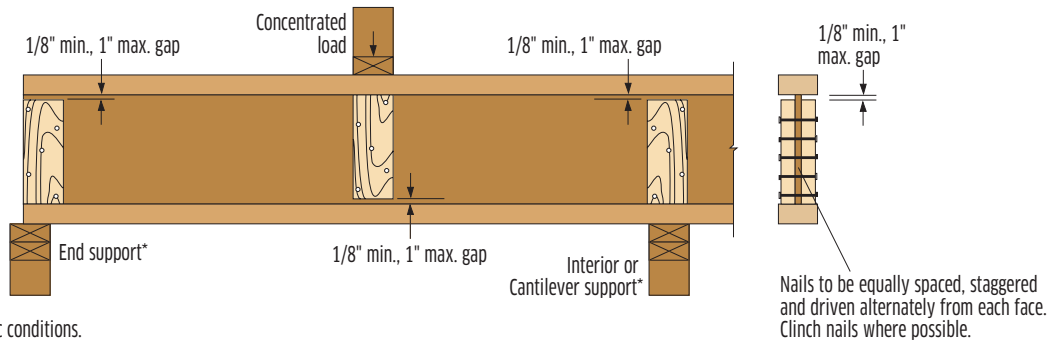

*Refer to framing plan for specific conditions.

Notes:

1. Web stiffeners shall be installed in pairs - one to each side of the web. Web stiffeners are always required for the "Bird's Mouth" roof joist bearing detail.
2. Web stiffeners shall be cut to fit between the flanges of the PWT™ I-Joist, leaving a minimum 1/8" gap (1" maximum). At bearing locations, the stiffeners shall be installed tight to the bottom flange. At locations of concentrated loads, the stiffeners shall be installed tight to the top flange.
3. Web stiffeners shall be cut from APA Rated OSB (or equal) or from PWT LVL or OSB Rim Board. 2x lumber is permissible. Do NOT use 1x lumber as it tends to split. Do NOT build up the required stiffener thickness from multiple pieces.
4. Web stiffeners shall be the same width as the bearing surface, with a minimum of 3-1/2."
5. See Web Stiffener Requirements for minimum stiffener thickness, maximum stiffener height and required nailing.

WEB STIFFENER REQUIREMENTS

Series	Depth	Minimum Thickness	Maximum Height	Nail Size*	Nail Quantity
PWI 18S, LPI 18 PWI 20S, LPI 20Plus PWI 32S, LPI 32Plus	9-1/2" 11-7/8"	23/32	6-3/8" 8-3/4"	8d (2-1/2")	3
PWI 20S, LPI 20Plus PWI 32S, LPI 32Plus	14" 16" 11-7/8"	23/32	10-7/8" 12-7/8" 8-3/4"	8d (2-1/2")	3
PWI 36L, LPI 36	14" 16"	23/32	10-7/8" 12-7/8"	8d (2-1/2")	4 5 6
PWI 42S, LPI 42Plus	9-1/2" 11-7/8"	1-1/2	6-3/8" 8-3/4"	10d (3")	3
PWI 42S, LPI 42Plus PWI 52S, LPI 52Plus	14" 16" 11-7/8"	1-1/2	10-7/8" 12-7/8" 8-3/4"	10d (3")	3 3 4
PWI 56L, LPI 56	14" 16"	1-1/2	10-7/8" 12-7/8"	10d (3")	5 6

*Nails may be Box or Common.

RIM & BLOCKING CAPACITY

Series	Depth	Factored Vertical Resistance (plf)
PWI 18S, LPI 18 PWI 20S, LPI 20Plus	9-1/2" 11-7/8"	2755 2552
PWI 20S, LPI 20Plus	14" 16"	2320 2175
PWI 32S, LPI 32Plus PWI 42S, LPI 42Plus	9-1/2" 11-7/8" 14" 16"	3190 3190 2320 2175
PWI 36L, LPI 36	11-7/8" 14" 16"	2610 2610 2610
PWI 52S, LPI 52Plus PWI 56L, LPI 56	11-7/8" 14" 16"	3480 3190 275

Notes:

1. The Factored Vertical Resistance is the capacity in pounds per lineal foot of length (plf) and shall not be adjusted for load duration.
2. Concentrated vertical loads require the addition of squash blocks. Do not use PWI rim or blocking to support concentrated vertical loads.
3. Lateral load capacity for all series above is 200 plf but may be limited by the connection details used. Do not exceed the Flange Face Nailing requirements at right.

FLANGE FACE NAILING

Series	Common Wire Nail Size	Minimum Nail Distance	
		oc Spacing	End
PWI 18S, LPI 18 PWI 20S, LPI 20Plus PWI 32S, LPI 32Plus PWI 42S, LPI 42Plus PWI 52S, LPI 52Plus	2-1/2" 3" 3-1/4" 3-1/2"	2" 3" 3" 4"	1" 1-1/2" 1-1/2" 1-1/2"
PWI 36L, LPI 36 PWI 56L, LPI 56	2-1/2" 3" 3-1/4" 3-1/2"	3" 3" 3" 5"	1-1/2" 1-1/2" 1-1/2" 1-1/2"

Notes:

1. Use only 2-1/2" or 3" nails when securing an PWI floor or roof joist to its supports.
2. Power-driven nails shall have a yield strength equivalent to common wire nails of the same shank diameter.

NAIL NAMES AND SIZES

Callout	Common Name	Min. Length	Diameter
8d	box	2-1/2"	0.113"
	common	2-1/2"	0.131"
10d	box	3"	0.128"
	common	3"	0.148"
16d	box	3-1/2"	0.135"
	common	3-1/2"	0.162"

Notes:

1. Common nails are assumed unless otherwise indicated.
2. 10d box may be substituted for 8d common nails.

Rim Board

FACTORED RIM BOARD RESISTANCE

Material	Grade	Thickness	Vertical Load Resistance			Lateral ^{4,5,6} Load Capacity (plf)
			Uniform		Concentrated	
			d ≤ 16"	16" < d ≤ 24"	d ≤ 24"	
OSB	APA C1/Rim Board7	1-1/8"	7033	4640	5075	219

Notes:

- The Factored Vertical Load Resistance shall not be increased for short-term load duration.
- The Factored Vertical Load Resistance is based on the resistance of the rim board and may need to be reduced based on the bearing resistance of the supporting wall plate or the attached floor sheathing.
- The Factored Concentrated Vertical Load Resistance is assumed to be applied through a minimum 4-1/2" bearing length (3-stud post).
- The Factored Lateral Load Resistance is based on a short-term load duration and shall not be increased.
- The Factored Lateral Load Resistance is based on the connections specified in the Installation details below.
- Additional framing connectors fastened to the face of the rim board may be used to increase lateral resistance for wind and seismic design.
- APA C1 grade in product standard ANSI/APA PRR 410 is equivalent to the rim board grade in product standard APA PRR-401C.

FACTORED UNIFORM LOADS (PLF) FOR RIM BOARD HEADERS: MAXIMUM 4' CLEAR SPAN

Material	Thickness	Rim Board Depth			
		9-1/2"	11-7/8"	2-Ply 14"	2-Ply 16"
OSB	1-1/8"	620 (3')	965 (3')	2220 (4-1/2')	2535 (4-1/2')

Notes:

- This table is for preliminary design for uniform gravity loads only. Final design should include a complete analysis of all loads and connections.
- The factored load resistances are for a maximum 4' clear span with minimum bearings for each end (listed in parentheses) based on the bearing resistance of the rim board. For headers bearing on wood plates, the bearing length may need to be increased based on the ratio of the bearing resistance of the rim board divided by the bearing resistance of the plate species.
- Standard load duration is assumed and shall be adjusted according to code.
- Depths greater than 11-7/8" shall be used with a minimum of two plies, as shown. Depths of 11-7/8" and less may be used as a two-ply header by multiplying the resistance by two.
- Multiple-ply headers shall be toe-nailed to the plate from both faces. Fasten the floor sheathing to the top of each ply to provide proper lateral support for each ply.
- For multiple-ply headers supporting top-loads only, fasten plies together with minimum 2-1/2" nails (common wire or spiral) at a maximum spacing of 12" oc. Use 2 rows of nails for 9-1/2" and 11-7/8". Use 3 rows for depths 14" and greater. Clinch the nails where possible. For side-loaded multiple-ply headers, refer to the Connection Resistance For Side-Loaded 2-Ply Rim Board Headers table below for the required nailing and the maximum side load that can be applied.
- The designer shall verify proper bearing for the header.
- Joints in the rim are not allowed over openings and must be located at least 12" from any opening.
- Refer to the "APA Performance Rated Rim Boards – Limit States Design" (Form No. D340 CA) for additional information including uniform load resistance for smaller openings.

FACTORED CONNECTION RESISTANCE FOR SIDE-LOADED 2-PLY RIM BOARD HEADERS (PLF)

Material	Thickness	Minimum Nail Size at 6" oc	3 Rows of Nails at 6" oc	4 Rows of Nails at 6" oc	5 Rows of Nails at 6" oc	6 Rows of Nails at 6" oc
OSB	1-1/8"	2-1/2"	1280	1707	2134	2561

Notes:

- This table represents the factored uniform side-load resistance of the connection for a 2-ply header. The total factored uniform load, including top-load and side-load, shall not exceed the factored uniform load resistance of the header as tabulated above.
- The tabulated side-load resistance is for standard load duration and shall be adjusted according to code.
- Use 3 rows of nails for 9-1/2" and 11-7/8"; 4 rows for 14" and 16"; 5 rows for 18" and 20"; 6 rows for 22" and 24" deep rim board.
- Nails may be either common wire or spiral. The factored resistances are based on spiral nails. Clinch the nails where possible.
- Headers consisting of more than 2 plies, alternate fastening or higher side loads are possible but require proper design of the connection.

INSTALLATION

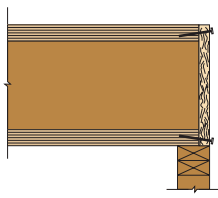
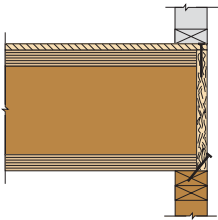
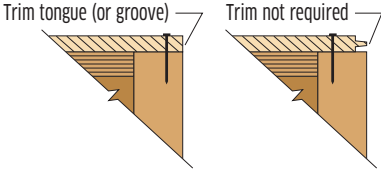
<p>RIM TO JOIST CONNECTION</p>  <p>Nail rim to I-Joist with one 8d (box or common) or 10d box nail into each flange.</p>	<p>DECK TO RIM AND RIM TO PLATE CONNECTIONS¹</p>  <ul style="list-style-type: none"> Nail floor sheathing to rim board with 8d nails at 6" oc. Nail wall plate through floor sheathing into rim per code. Toe-nail rim board to wall plate with 8d nails at 6" oc. <p>See T&G Trim Requirements detail and table.</p>	<p>T&G TRIM REQUIREMENTS²</p> <p>See T&G Trim Requirements table below for when to trim tongue or groove.</p>  <p>Trim tongue (or groove) Trim not required</p>
--	---	---

Notes:

- Additional framing connectors to the face of the rim board may be used to increase lateral capacity for wind and seismic design.
- Trim the tongue or groove of the floor sheathing in accordance with the T&G Trim Requirements table.

T&G TRIM REQUIREMENTS

Floor Sheathing Thickness	Rim Board Thickness			
	1"	1-1/8"	1-1/4"	> 1-1/4"
≤ 7/8"	Trim	Not Required	Not Required	Not Required
> 7/8"	Trim	Trim	Trim	Not Required

Warnings



WARNINGS

The following conditions are NOT permitted!

Do not use visually damaged products without first checking with your local PWT™ distributor or sales office.

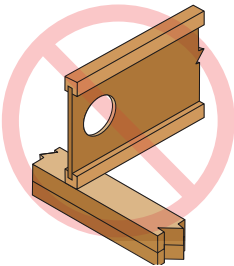
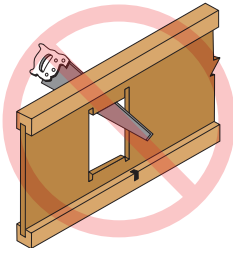
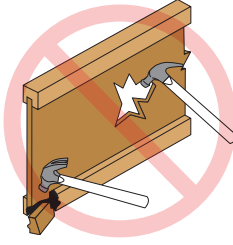
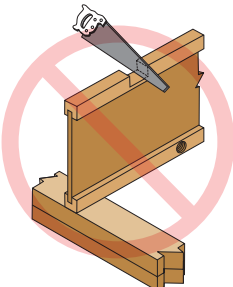
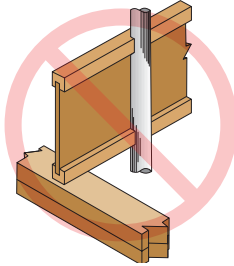
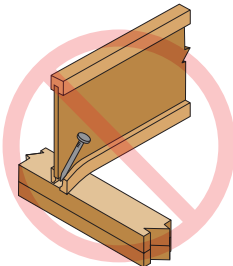
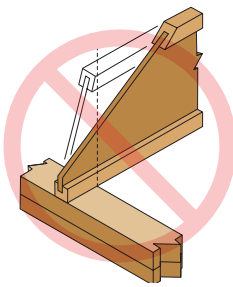
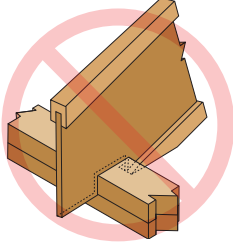
<p>DON'T put holes too close to supports.</p>  <p>Refer to hole chart for correct location.</p>	<p>DON'T overcut hole and damage flange.</p> 	<p>DON'T make hole with hammer unless knock-out is provided.</p>  <p>DON'T hammer on flange and damage joist.</p>	<p>DON'T cut or notch flange.</p>  <p>DON'T drill flange.</p>
<p>DON'T cut flange for pipes.</p> 	<p>DON'T use 16d nails.</p>  <p>Refer to Joist End Nailing detail for correct sizes and locations.</p>	<p>DON'T cut beyond inside edge of bearing.</p> 	<p>DON'T support I-Joist on web.</p> 



Handling and Storage

HANDLING AND STORAGE GUIDELINES

- **WARNING:** Failure to follow proper procedures for handling, storage and installation could result in unsatisfactory performance, unsafe structures and possible collapse.
- Keep PWT™ products dry. These products are intended to resist the effects of moisture on structural performance from normal construction delays but are not intended for permanent exposure to the weather.
- Unload products carefully, by lifting. Support the bundles to reduce excessive bowing. Individual products should be handled in a manner which prevents physical damage during measuring, cutting, erection, etc. I-Joists shall be handled vertically and not flatwise.
- Keep products stored in wrapped and strapped bundles, stacked no more than 10' high. Support and separate bundles with 2 x 4 (or larger) stickers spaced no more than 10' apart. Keep stickers in line vertically.
- Product must not be stored in contact with the ground, or have prolonged exposure to the weather.
- Use forklifts and cranes carefully to avoid damaging product.
- Do not use a visually damaged product. Call your local PWT distributor for assistance when damaged products are encountered.
- For satisfactory performance, PWT I-Joists and LVL must be used under dry, covered and well-ventilated interior conditions in which the average equilibrium moisture content (MC) of lumber is 15% or less over a year and does not exceed 19% at any time.
- For built-up members, PWT I-Joists and LVL shall be dry before nailing or bolting to avoid trapping moisture.
- PWT™ I-Joists and LVL shall not be used for unintended purposes such as ramps and planks.

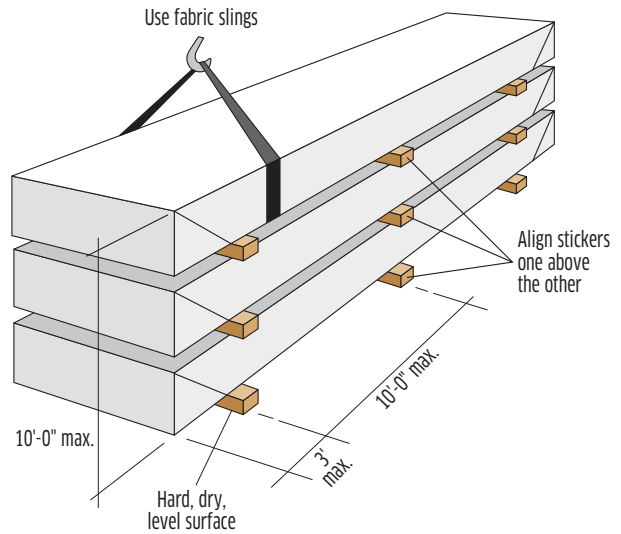

PWT™

FOCUSED ON EWP

1850 Park Lane Burlington, WA 98233

TF 888.707.2285

pwtewp.com

For product catalog and complete warranty details or for more information on the full line of PWT products or the nearest distributor, visit pwtewp.com.

PWT products are manufactured at different locations in the United States and Canada.

PWT™

I-JOIST

© 2024 Pacific Woodtech Corporation. All rights reserved. APA, APA Rated, and APA Product Report are registered trademarks of APA – The Engineered Wood Association. SIMPSON Strong-Tie® is a registered trademark of Simpson Strong-Tie Company, Inc. MiTek® is a registered trademark of MiTek Holdings, Inc. PWT™ is a registered trademark of Pacific Woodtech Corporation. Printed in USA. Specifications (details) subject to change without notice.

NOTE: PWT periodically updates and revises its product information. To verify that this version is current, contact the nearest sales office, visit pwtewp.com, or call 888.707.2285.